

# LIMITED WARRANTY

Bull Europe Ltd.  
Zamco Buildings  
Mill Street  
Qormi, Qrm3103,  
Malta

Bull Europe Ltd warrants to the original purchaser at the original site of delivery with proof of purchase of each appliance that when subject to normal residential use, it is free from defects in workmanship and materials for the

periods specified below. This warranty excludes appliances used in rental or commercial applications. It does not apply to rust, corrosion, oxidation or discoloration, which may occur due to moisture or overheating, unless the affected component becomes inoperable. It does not cover labor or labor related charges. There will be a shipping and handling charge for the delivery of the warranty part(s).

Our obligation under this warranty is limited to repair or replacement, at our option, of the product during the warranty period. The extent of any liability of Bull Europe Ltd under this warranty is limited to repair or replacement. This warranty does not cover normal wear of parts, damage resulting from any of the following: negligent use or misuse of the product, use on improper fuel/gas supply, use contrary to operating instructions, or alteration by any person other than our factory service center. The warranty period is not extended by such repair or replacement.

**Warranty claim procedure:** If you require service or parts for your Bull grill or if you have any questions about warranty, please contact your local dealer or our Warranty Service Center for direct assistance. Our hours of operation are 8AM to 5PM GMT+1. Our phone number is + 356 22792113 and our FAX number is + 356 22792 120. E.mail :service@bullbbq.eu.

Product repair as provided under this warranty is your exclusive remedy. Bull Europe Ltd. shall not be liable for any incidental or consequential damages for breach of any express or implied warranty on its products. Except to the extent prohibited by applicable law, any implied warranty or merchantability or fitness for a particular purpose on this product to the duration of the above warranty. Some EU Countries do not allow the exclusion or limitation of incidental or consequential damages, or allow limitations on how long an implied warranty lasts, so the above limitations or exclusions may not apply to you. This warranty gives you specific legal rights, and you may have other rights, which vary from Country to Country



## PREMIUM OUTDOOR RATED REFRIGERATOR

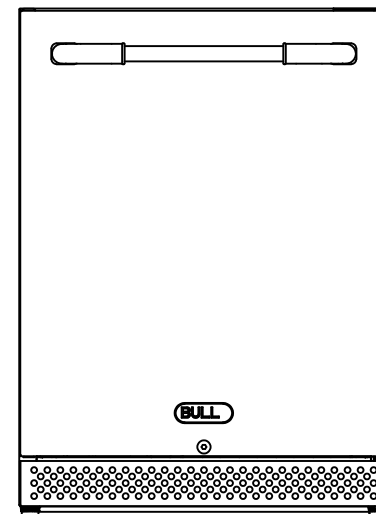

### INSTRUCTION MANUAL

BEFORE USE, PLEASE READ AND FOLLOW ALL SAFETY RULES AND OPERATING INSTRUCTIONS.

Write Serial No. (on upper left corner of inside cabinet) here:

\_\_\_\_\_

## TABLE OF CONTENTS

<b>Appliance Safety</b>	<b>3</b>
<b>Important Safeguards</b>	<b>3 - 4</b>
<b>Location of Parts</b>	<b>5</b>
<b>Installation Instructions</b>	<b>5 - 7</b>
Before Using Your Appliance	5
Installation of Your Appliance	5 - 6
Electrical Connection	6
Extension Cord	6
Reversing the Door Swing of Your Appliance	7
Installing the Stainless Steel Handle	7
<b>Operating Your Appliance</b>	<b>8 - 9</b>
Control Panel	8 - 9
Defrosting	9
Temperature Alarm / Door Alarm	9
Door Lock	9
Preparation	9
Shelves	9
<b>Care and Maintenance</b>	<b>10</b>
Cleaning Your Appliance	10
Power Failure	10
Vacation Time	10
Moving Your Appliance	10
Energy Saving Tips	10
<b>Troubleshooting</b>	<b>11 - 12</b>



## TROUBLESHOOTING

You can solve many common problems easily, saving you the cost of a possible service call. Try the suggestions below to see if you can solve the problem before calling the servicer.

### Troubleshooting Guide

PROBLEM	POSSIBLE CAUSE	REMEDY
Appliance does not operate.	Appliance is not connected to a power supply. The appliance is turned off. Tripped circuit breaker or a blown fuse.	Connect the appliance. Switch on the appliance. Switch on circuit breaker or replace fuse.
Appliance is not cold enough.	The temperature is not set correctly. The ambient temperature could require a lower temperature setting. The door was opened too often.  The door was not closed completely. Door is not hermetically sealed.	Check the set temperature. Set a lower temperature.  Do not open the door more often than necessary. Close door properly. Check the door seal and clean or replace.  Clean the condenser when necessary. Clear the obstructions and clean the dust.
Appliance turns itself on and off frequently.	The room temperature is higher than average. A large amount of food has been added to the unit.  The door is open too often.  The door is not closed completely. The door gasket does not seal properly.	Put the appliance in a cooler place.  Leave the appliance to work for a while until the set temperature has been reached. Do not open the door more often than necessary. Close door properly. Check the door seal and clean or replace.
The light does not work.	Appliance is not connected to a power supply. Tripped circuit breaker or a blown fuse. The light was switched off on the control panel.	Connect the appliance. Switch on circuit breaker or replace fuse. Switch on the light.
Vibrations	The appliance is not properly leveled.	Level the appliance with the adjustable feet.
The appliance seems to make too much noise.	The rattling noise may come from the flow of the refrigerant, which is normal. As each cycle ends, you may hear gurgling sounds caused by the flow of refrigerant in your appliance. If temperature fluctuations occur, the contraction and expansion of the inner walls may cause popping and cracking noises.  The appliance is not properly level.	Level the appliance with the adjustable feet.
The door will not close properly.	The appliance is not properly level.  The door was reversed and not properly installed. The gasket is dirty. The shelves are out of position.	Level the appliance with the adjustable feet. Check the door hinge and reassemble correctly. Clean the door gasket. Check the shelves and refit correctly.
The alarm sounds and the temperature display flashes.	Has the appliance door been open for longer than 60 seconds? If not, then the temperature has risen higher or fallen lower than the temperature that has been set. This could be due to: - The appliance door being opened too often. - The ventilation opening being covered or too dusty. A lengthy interruption in the power supply. A large amount of food has been added to the unit.	If yes, close the door.  Do not open the door more often than necessary. Clear the obstructions and clean the dust. Leave the appliance to work for a while until the set temperature has been reached.



## CARE AND MAINTENANCE

### CLEANING YOUR APPLIANCE

Turn off the power, unplug the appliance, and remove all items, including shelves.

Wash the inside surfaces with a solution of warm water and baking soda (about 2 tablespoons of baking soda to a quart of water).

Wash the shelves with a mild detergent solution.

Wring excess water out of the sponge or cloth when cleaning the area where the controls are located or any electrical parts.

Wash the outside cabinet with warm water and mild liquid detergent. Rinse well and wipe dry with a clean soft cloth.

Use an approved stainless steel cleaner to clean the door and handle. Do not use steel wool or a steel brush on the stainless steel.

#### **CAUTION:**

*Failure to unplug the appliance during cleaning could result in electrical shock or other personal injury.*

### POWER FAILURE

Most power failures are corrected within a few hours and should not affect the temperature of your appliance if you minimize the number of times the door is opened. If the power is going to be off for a longer period of time, you need to take the proper steps to protect the contents.

### VACATION TIME

**Short vacations:** Leave the appliance operating during vacations of less than three weeks.

**Long vacations:** If the appliance will not be used for several months, remove all items and turn off the appliance. Clean and dry the interior thoroughly. To prevent odor and mold growth, leave the door open slightly, blocking it open if necessary.

### MOVING YOUR APPLIANCE

1. Remove all items.
2. Securely tape down all loose items (shelves) inside your appliance.
3. Turn the adjustable legs up to the base to avoid damage.
4. Tape the door shut.
5. Be sure the appliance stays secure in the upright position during transportation. Also protect the outside of the appliance with a blanket or similar item.

### ENERGY SAVING TIPS

The appliance should be located in the coolest area of the room or outdoor location, away from heat-producing appliances and out of direct sunlight.

Ensure that the unit is adequately ventilated. Never cover air vents.

Do not keep the door open any longer than necessary.

Let hot foods cool to room temperature before placing in the unit. Overloading the unit forces the compressor to run longer.

Be sure to wrap foods properly, and wipe containers dry before placing them in the unit. This cuts down on frost build up inside the unit.

Unit shelves and storage bins should not be lined with aluminum foil, wax paper or paper toweling. Liners interfere with cold air circulation, making the unit less efficient.

Organize and label stored items to reduce door openings and extended searches. Remove as many items as needed at one time, and close the door as soon as possible.



## APPLIANCE SAFETY

Your safety and the safety of others are very important.

We have provided many important safety messages in this manual and on your appliance. Always read and obey all safety messages.



This is the Safety Alert Symbol. The symbol alerts you to potential hazards that can kill or injure you and others. All safety messages will follow the Safety Alert Symbol and either the word DANGER or WARNING.

**! DANGER !**

DANGER means that failure to heed this safety statement may result in severe personal injury or death.

**! WARNING**

WARNING means that failure to heed this safety statement may result in extensive product damage, serious personal injury, or death.

All safety messages will alert you about the potential hazard, tell you how to reduce the chance of injury, and let you know what can happen if the instructions are not followed.

## IMPORTANT SAFEGUARDS



Before the appliance is used, it must be properly positioned and installed as described in this manual, so read the manual carefully. To reduce the risk of fire, electrical shock or injury when using the appliance, follow basic precautions, including the following:

**! DANGER !**

Plug into a grounded 3 prong outlet, do not remove grounding prong, do not use an adapter, and do not use an extension cord.

Replace all panels before operating

It is recommended that a separate circuit serving only your appliance be provided. Use receptacles that cannot be turned off by a switch or pull chain

Never clean appliance parts with flammable fluids. These fumes can create a fire hazard or explosion. And do not store or use gasoline or other flammable vapors and liquids in the vicinity of this or any other appliance. The fumes can create a fire hazard or explosion.

Do not connect or disconnect the electric plug when your hands are wet.

Unplug the appliance or disconnect power before cleaning or servicing. Failure to do so can result in electrical shock or death.

Do not attempt to repair or replace any part of your appliance unless it is specifically recommended in this manual. All other servicing should be referred to a qualified technician.



## WARNING

FOLLOW WARNING CALL OUTS BELOW ONLY WHEN APPLICABLE TO YOUR MODEL  
Use two or more people to move and install appliance. Failure to do so can result in back or other injury.

To ensure proper ventilation for your appliance, the front of the unit must be completely unobstructed. Choose a well-ventilated area with temperatures above 10°C and below 43°C.

The appliance should not be located next to ovens, grills or other sources of high heat.

The appliance must be installed with all electrical, water and drain connections in accordance with state and local codes. A standard electrical supply (220 V AC only, 50 Hz), properly grounded in accordance with the National Electrical Code and local codes and ordinances, is required.

Do not kink or pinch the power supply cord of the appliance.

The size of the fuse (or circuit breaker) should be 1.3 amperes.

It is important that the appliance be leveled in order to work properly. You may need to make several adjustments to level it.

All installations must be in accordance with local plumbing code requirements.

Make certain that the pipes are not pinched, kinked or damaged during installation.

Check for leaks after connection.

Never allow children to operate, play with or crawl inside the appliance.

Do not use solvent-based cleaning agents or abrasives on the interior. These cleaners may damage or discolor the interior.

Use this appliance only for its intended purpose as described in this *Instruction Manual*.

Keep fingers out of the "pinch point" areas. Clearances between the door and cabinet are necessarily small. Be careful closing door when children are in the area.

## DANGER

### **Risk of child entrapment!**

Child entrapment and suffocation are not problems of the past. Junked or abandoned appliances are still dangerous, even if they will "just sit" for a few days".

*Before discarding your old refrigerator:*

*Take off the doors*

*Leave the shelves in place so that children may not easily climb inside.*

**- SAVE THESE INSTRUCTIONS -**

### Interior Light

The unit is equipped with an interior LED light which will be turned ON when the door is open. And the interior fan is stopped at the same time.

You can press  manually to turn on or turn off the light.

### DEFROSTING

The unit defrosts automatically in normal operating conditions.

The evaporator behind the rear wall of the unit defrosts automatically. The condensate collects in the drainage channel behind the rear wall of the unit, and flows through the drainage hole into the drip tray by the compressor where it evaporates.

However, frost may accumulate on the evaporator if the unit is repeatedly opened in a high heat or high humidity location. If this frost pattern does not clear within 24 hours, your unit will require manual defrosting.

Press  and hold for 6 seconds, the unit will be defrosted.

To stop defrost, please repeat the same interaction.

### TEMPERATURE ALARM / DOOR ALARM

An audible alarm sounds if the storage temperature is not cold enough. The temperature display flashes at the same time.

The cause of the temperature being too high may be:

- Warm fresh food was placed inside
- Too much warm ambient air flowed in when rearranging and removing stored items
- Power failure for some time
- The appliance is faulty

The audible alarm is automatically silenced and the temperature display stops flashing when the temperature is sufficiently cold again.

If the door has been left open for more than 60 seconds, the alarm will sound. Pressing any key once can switch off the audible alarm.

### DOOR LOCK

Your unit is provided with a lock and key combination.

The keys are located inside the plastic bag that contains the *Instruction Manual*. Insert the key into the lock and turn it counter-clockwise to unlock the door. To lock the door, do the reverse operation, making sure the metal pin is engaged completely. Remove the key and put it in a secure place for safekeeping.

### PREPARATION

Position the Shelf-Supports inside the racks on the sides as illustrated below, at your required level, and then place the shelves firmly on the supports.

### SHELVES

To prevent damaging the door gasket, make sure to have the door all the way open when pulling the shelves out of the Shelf-Supports.

Any of the shelves can be removed to store larger items. When removing the shelf out of the Shelf-Supports, make sure to remove all items first.

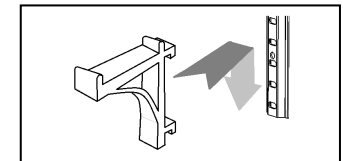

## OPERATING YOUR APPLIANCE

It is recommended that you install the appliance in a place where the ambient temperature is between 10°C and 43°C . If the ambient temperature is above or below recommended temperatures, the performance of the unit may be affected. For example, placing your unit in extremely cold or hot conditions may cause interior temperatures to fluctuate. The operating temperature range may not be reached.

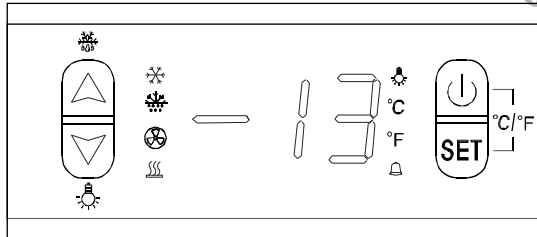

### CONTROL PANEL



#### ON/OFF Power



To turn the appliance ON or OFF , press and hold the POWER key  for 5 seconds.

#### UP and DOWN



Press  first ,then press  or  button to increase(warm) or decrease(cool) the set temperature by 1°C/1°F.

Press  again, the temperature is selected and shows the actual temperature. If no other further operation in 6 seconds, display will show actual temperature in the cooler.

#### °C/°F Selector

Selects the temperature display setting in Fahrenheit or Celsius degrees. To change the temperature from Fahrenheit to Celsius or from Celsius to Fahrenheit, press  and  at the sametime, then hold for 6 seconds.

#### Setting the Temperature Control

The temperature you are setting will increase by one degree each time you press the  key, and will decrease by one degree each time you press the  key.

The range of the temperature control is from -5 °C to 20 °C.

To view the set temperature at any time, press the  key. The set temperature will flash in the display window for 6 seconds. After 6 seconds, the temperature inside the unit will reappear in the display window.

(The temperature preset at the factory is 1°C).

## LOCATION OF PARTS

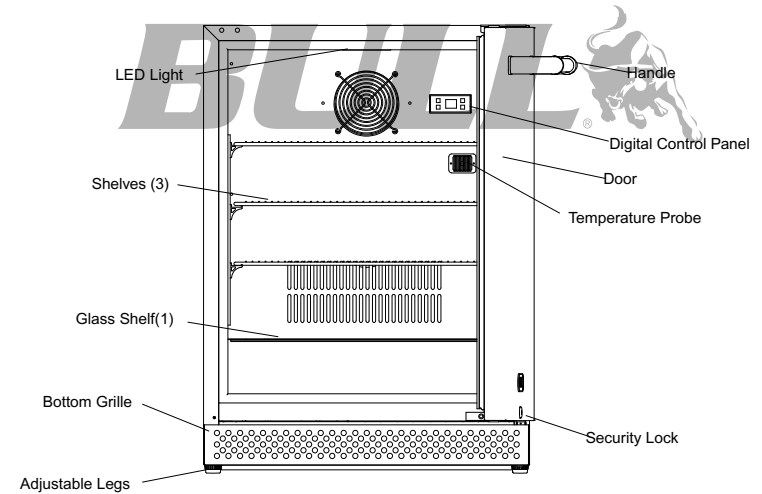

## INSTALLATION INSTRUCTIONS

### BEFORE USING YOUR APPLIANCE

Remove the exterior and interior packing.

Before connecting the appliance to the power source, let it stand upright for approximately 2 hours. This will reduce the possibility of a malfunction in the cooling system from handling during transportation.

Clean the interior surface with lukewarm water using a soft cloth.

Install the handle on the door, if it is not already attached ( See page 7.)

### INSTALLATION OF YOUR APPLIANCE

The appliance is designed for built-in recessed or free-standing installation.

**Note:** may be used this appliance for the storage of medicine and other medical products.

Place your appliance on a floor that is strong enough to support it when it is fully loaded. To level the unit, adjust the front leveling legs.

Take care that the air vent at the front of the appliance is never covered or blocked in any way.

**Note:** It is recommended that you do not install the appliance near an oven, radiator or other heating source. And heat sources may increase electrical consumption. Don't install in a location where the temperature will fall below 10°C. For best performance, do not install the appliance behind a cabinet door or block the base grille.

Avoid locating the unit in moist areas.

Plug the appliance into an exclusive, properly grounded wall outlet.

## ELECTRICAL CONNECTION



### WARNING

Improper use of the grounded plug can result in the risk of electrical shock. If the power cord is damaged, have it replaced by a qualified electrician or an authorized service center.

This appliance should be properly grounded for your safety. The power cord of this appliance is equipped with a three-prong plug which mates with standard three-prong wall outlets to minimize the possibility of electrical shock.

Do not under any circumstances cut or remove the third (ground) prong from the power cord supplied. For personal safety, this appliance must be properly grounded. Any questions concerning power and/or grounding should be directed toward a certified electrician or an authorized service center.

This appliance requires a standard 220V Volt AC ~50Hz three-prong grounded electrical outlet. Have the wall outlet and circuit checked by a qualified electrician to make sure the outlet is properly grounded. When a standard 2-prong wall outlet is encountered, it is your responsibility and obligation to have it replaced with a properly grounded 3-prong wall outlet.

To prevent accidental injury, the cord should be secured behind the appliance and not left exposed or dangling.

The appliance should always be plugged into its own individual electrical outlet which has a voltage rating that matches the rating label on the appliance. This provides the best performance and also prevents overloading house wiring circuits that could cause a fire hazard from overheating. Never unplug the appliance by pulling on the power cord. Always grip the plug firmly and pull straight out from the receptacle. Repair or replace immediately all power cords that have become frayed or otherwise damaged. Do not use a cord that shows cracks or abrasion damage along its length or at either end. When moving the appliance, be careful not to damage the power cord.

## EXTENSION CORD

Because of potential safety hazards under certain conditions, it is strongly recommended that you do not use an extension cord with this appliance. However, if you must use an extension cord it is absolutely necessary that it be a CE-Listed, 3-wire grounding type appliance extension cord having a grounding type plug and outlet and that the electrical rating of the cord be 220 volts and at least 1.3 amperes.



## REVERSING THE DOOR SWING OF YOUR APPLIANCE

This unit has the capability of the door opening from either the left or right side. The unit is delivered to you with the door opening from the left side. Should you desire to reverse the opening direction, please follow the reversal instructions shown below.

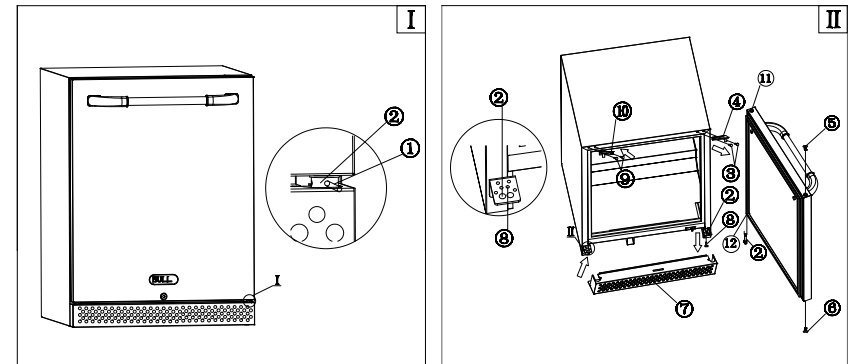

**NOTE:** All parts removed must be saved to allow the door swing to be reversed.

1. Use a long screw to remove the pin(1) by rotating the axes(2) clockwise.
2. Remove the screws(3) from the right top hinge(4). Gently pull down the door and place it on a padded surface to avoid the risk of damage.
3. To hang the axes(2) in the opposite hole at the door bottom and put the cover caps(5) and (6) to cover the holes(11) and (12) at the same time.
4. Transfer the top left screws(9) to cover the top right holes.
5. Remove the kick plate(7) by unscrewing the lock screws on both sides, then transfer the screw(8) to the left hinge plate.
6. Reinstall the kick plate and lock the screws.
7. Place the axes(2) on the left hinge plate and screw the alternative left top hinge(10), included in the fittings, onto the left hand side of cabinet and tighten it after the door is leveled.
8. Put the pin(1) in the axes(2). Adjust it and make sure the self-closing function can work.

## INSTALLING THE STAINLESS STEEL HANDLE

This appliance includes a stainless steel handle that is not required to operate the unit. To install the handle, follow the instructions below:

1. Take out the screws and wrench from bag in cabinet, use a screw driver to put the screws on the top of door where the handle is to be installed.
2. Align the handle with the screws, tighten the screws using the wrench until the handle is both flush and secured tightly against the door side. (DO NOT over-tighten as this may cause damage to the door surface.)

