

Sunday

Expert



Sunday
The new way of grilling

With a BBQ, it's always party time!

A barbecue on a cool summer evening: a special way to spend time with friends and family, outdoors, making merry, eating delicious healthy food.

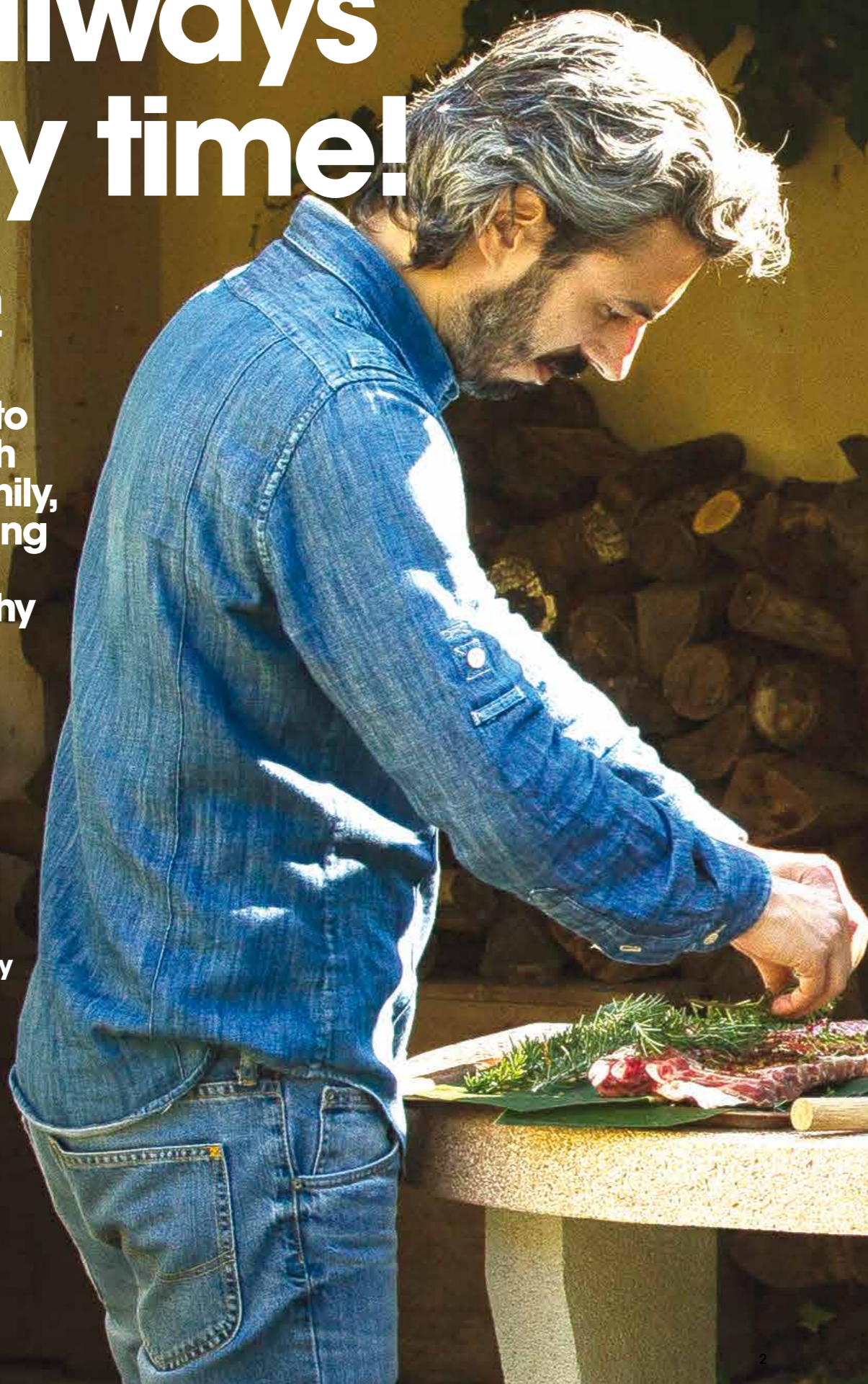

Contents

Barbecues in masonry
p_6

Barbecues in metal
p_32

Metal ovens
p_58

Ovens
in refractory material
p_80

Accessories
p_88

Sunday
The new way of grilling

Materials and finishes.

Significant aesthetic value, use of marble chips with natural colours, long lasting durability, revolutionary Crystal worktops, high heat resistance making it possible to use wood. The quality and sturdiness of Sunday materials can be recognised at first sight.

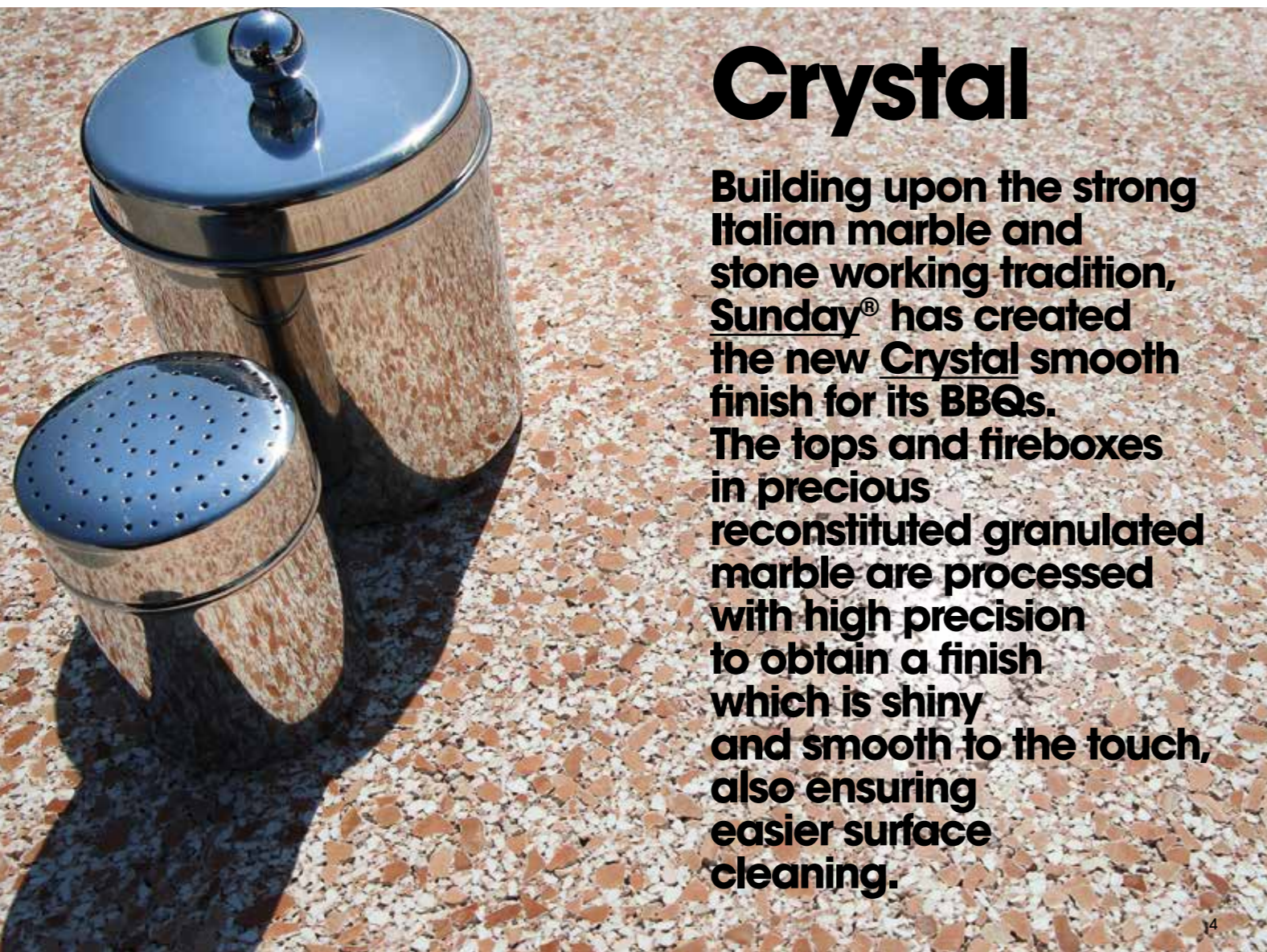

Crystal

Building upon the strong Italian marble and stone working tradition, Sunday® has created the new **Crystal smooth finish** for its BBQs. The tops and fireboxes in precious reconstituted granulated marble are processed with high precision to obtain a finish which is shiny and smooth to the touch, also ensuring easier surface cleaning.

Here is an overview of the existing finishes in the range.

	BASIC	STONE	CRYSTAL
BIANCO CARRARA Cultured marble			
DECOR BRICK Cultured marble			
NERO GALAXY Cultured marble			
ROSA ASIAGO Cultured marble			
SILVER GREY Cultured marble			
RED ELEMENTS work tops, risers, roofs, fireboxes pre-hoods, structures.			

Finishing/colour combinations are not customisable.

Certifications and quality

Over the years, Sunday has stood out for its commitment to complying with the main and strictest regulations and certifications in force, guaranteeing the best quality of its products.

Certifications
EN1860
EN498

Agencies
IMQ
TUV
GASTECH

Quality Control
AQL4

Melody. Cooking outdoors, in style.



With its wide smooth Crystal tops that facilitate cleaning, the elegant lines and rich outfitting which include sink, gas cooker and the new gas grill with lid, Melody is a new concept of the outdoor kitchen, easy and versatile.

Typical compositions: Melody 4B



Optional sink feature to be able to prepare food directly in the garden



The BBQ works with wood and charcoal, is fitted with a biologic cooking rack for fat-free cooking

"Easy fire" ventilated brazier to make embers in half the time



Tops made with smooth **Crystal** finishes, to ensure easy surface cleaning

Individual element codes Melody:

- Melody Acqua Crystal 5714007
- Melody BBQ Crystal 5714004
- Melody Grill Crystal 5715004
- Melody Isola Crystal 5714009
- Melody anta Bamboo 4009025

Doors made in solid wood



Convenient support shelves



Rotisserie-ready



Wide cooking surface with enamelled plate for easy cleaning



Optional gas grill feature for even easier and quicker cooking; flame distributor system which does not require lava rock



Melody 3 Acqua

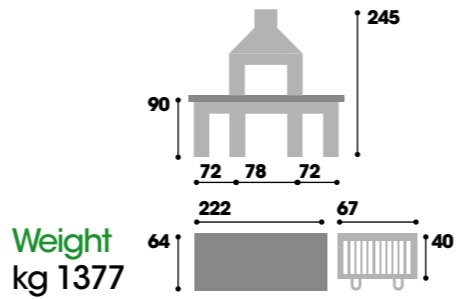

Melody 3 Grill

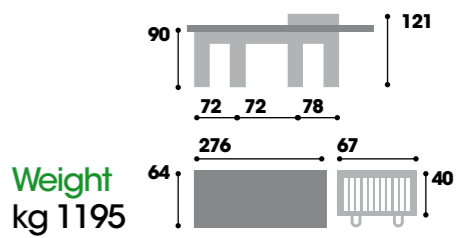

Melody 3 Young

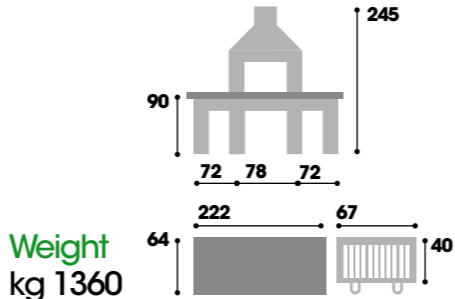

Melody 2

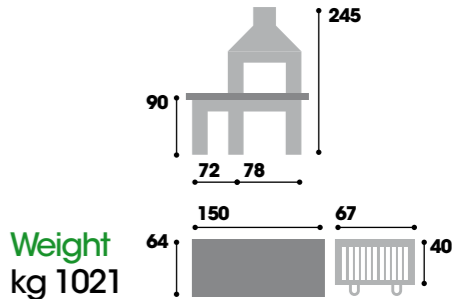

Melody 2 Young

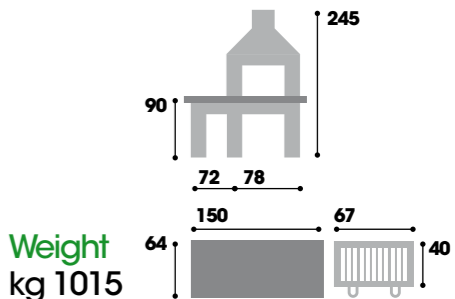

Masonry BBQs.

An expression of the Italian tradition of getting together, eating delicious healthy food. A truly comprehensive range of cooking functions, designs and aesthetic finishes to furnish your garden.



New Jersey

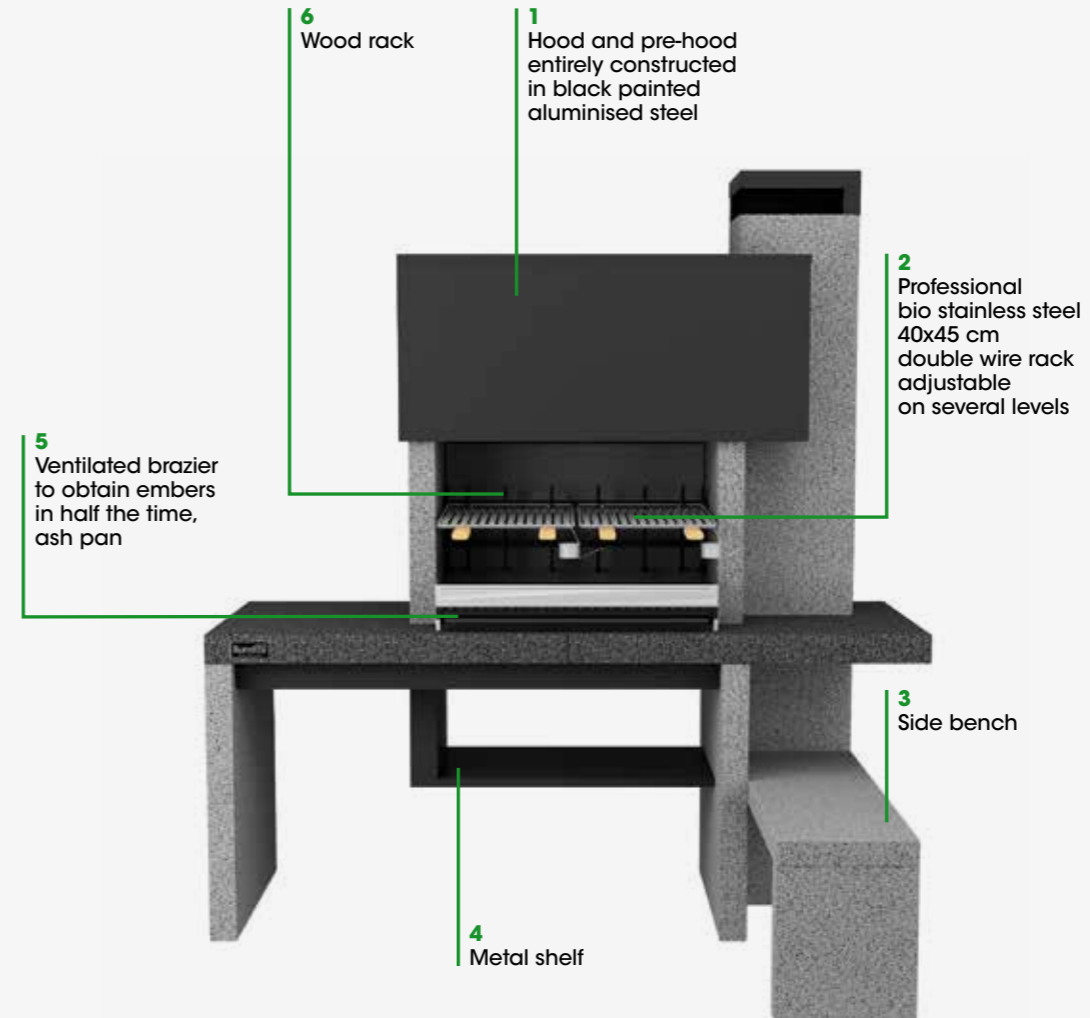

- Easy assembly with Betonfast (included)
- It uses wood and charcoal
- Smooth Crystal top
- Requires no painting
- Biologic stainless steel cooking rack



Barbecue in antiqued granulated marble with smooth Crystal top, black painted steel hood, counter top and side bench.
Code
5710131

Cooking rack
two 40x45cm bio
Servings
10/12
Weight
kg 1100
Packaging
120x105cm

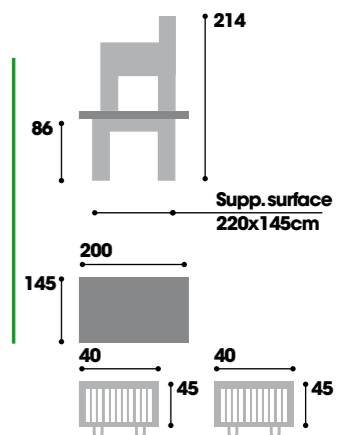

Non-reversible model, designed only with flue and bench on the right.

Recommended accessories
> 4008010 Rotisserie Kit - 70cm
> 40180051 Serpentine marble plate - 40x30cm
> 4012053 Set of 5 stainless steel accessories



Toronto

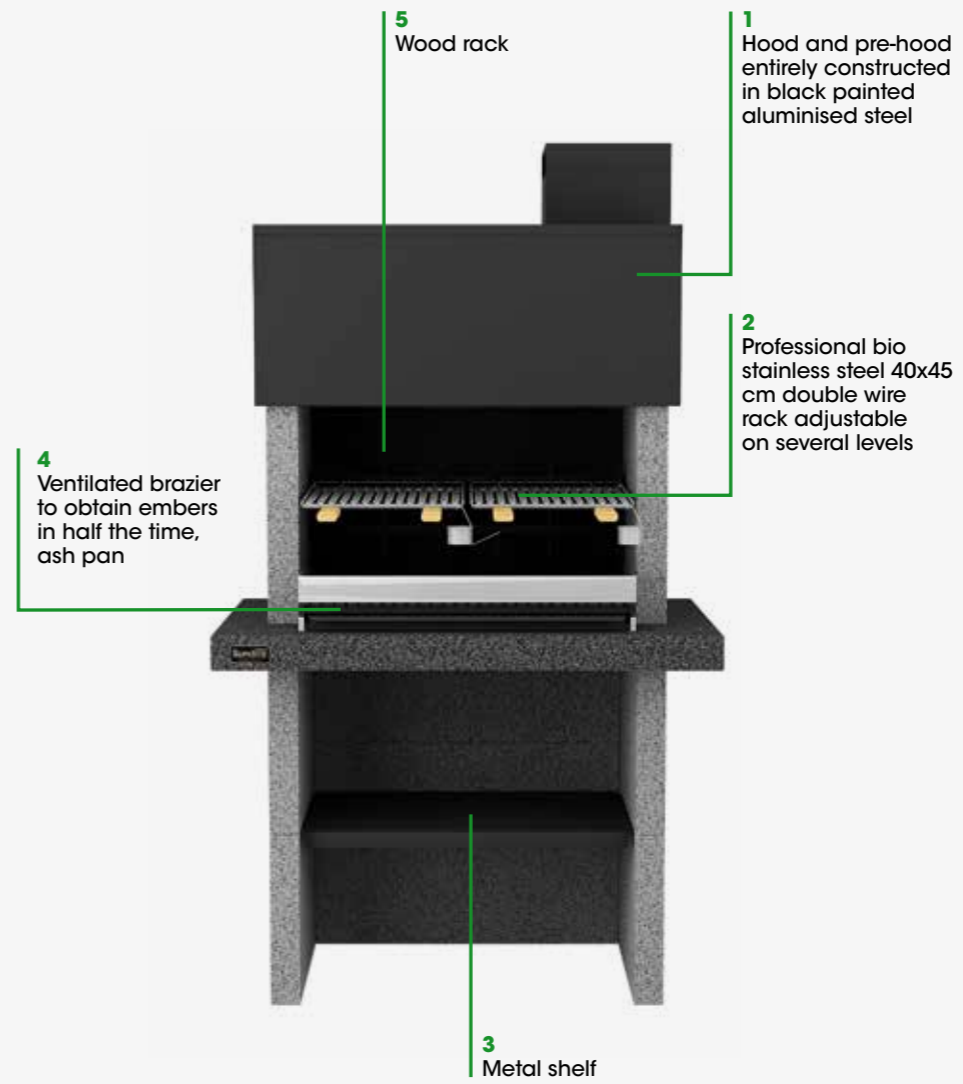

- Easy assembly with Betonfast (included)
- It uses wood and charcoal
- Smooth Crystal top
- Requires no painting
- Biologic stainless steel cooking rack

Barbecue in antiqued granulated marble with smooth Crystal top, black painted steel hood, counter tops.

Code
5710134

Cooking rack
two 40x45cm bio
Servings
10/12
Weight
kg 680
Packaging
120x80cm

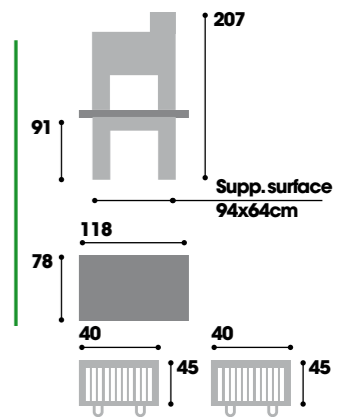

Non-reversible model, designed only with flue on the right.

Recommended accessories
> 4008010 Rotisserie Kit - 70cm
> 4012053 Set of 5 stainless steel accessories



Montreal

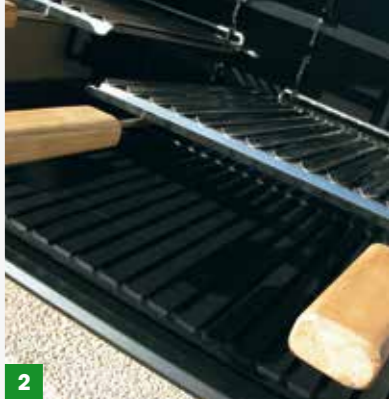
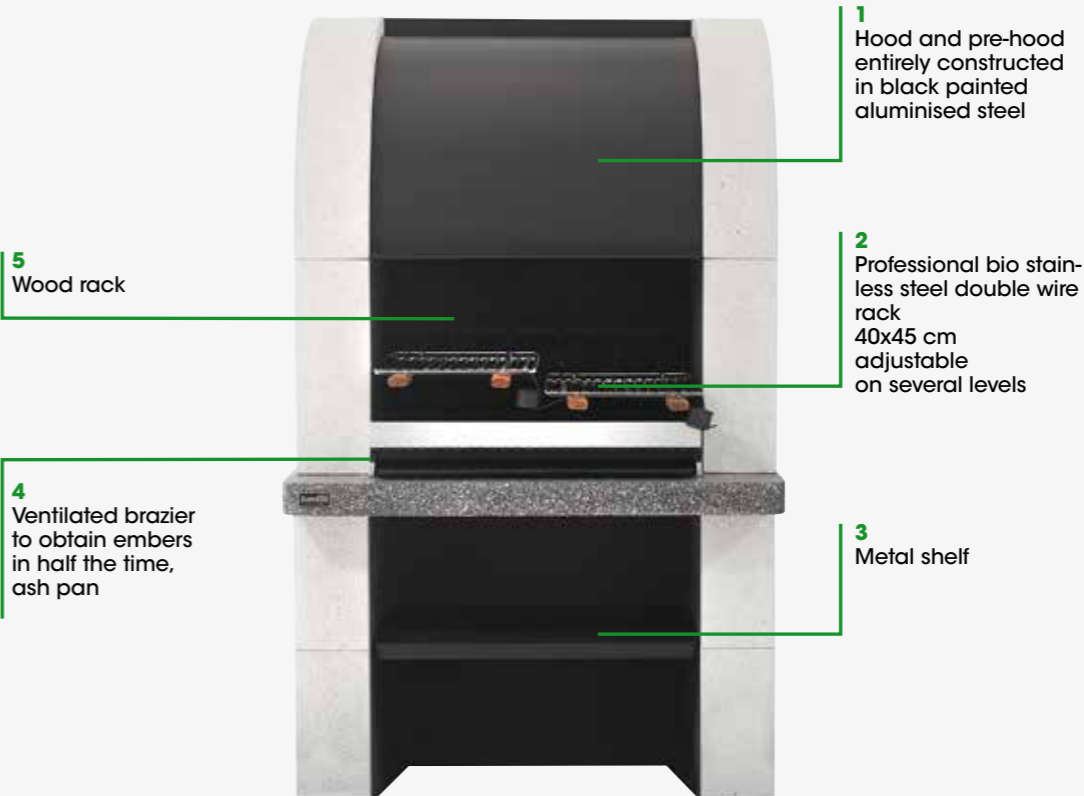

- Easy assembly with Betonfast (included)
- It uses wood and charcoal
- Smooth Crystal top
- Requires no painting
- Biologic stainless steel cooking rack

Antiqued granulated marble barbecue with smooth Crystal top, black painted steel hood, sides with exposed brickwork finish, wide counter top.

Code
5710133

Cooking rack
two 40x45cm bio
Servings
10/12
Weight
kg 770
Packaging
120x80cm

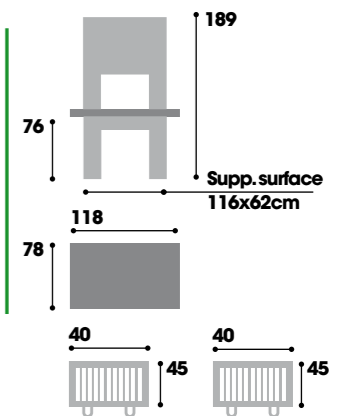

Recommended accessories
> 4008010 Rotisserie Kit - 70cm
> 4012053 Set of 5 stainless steel accessories



Kansas

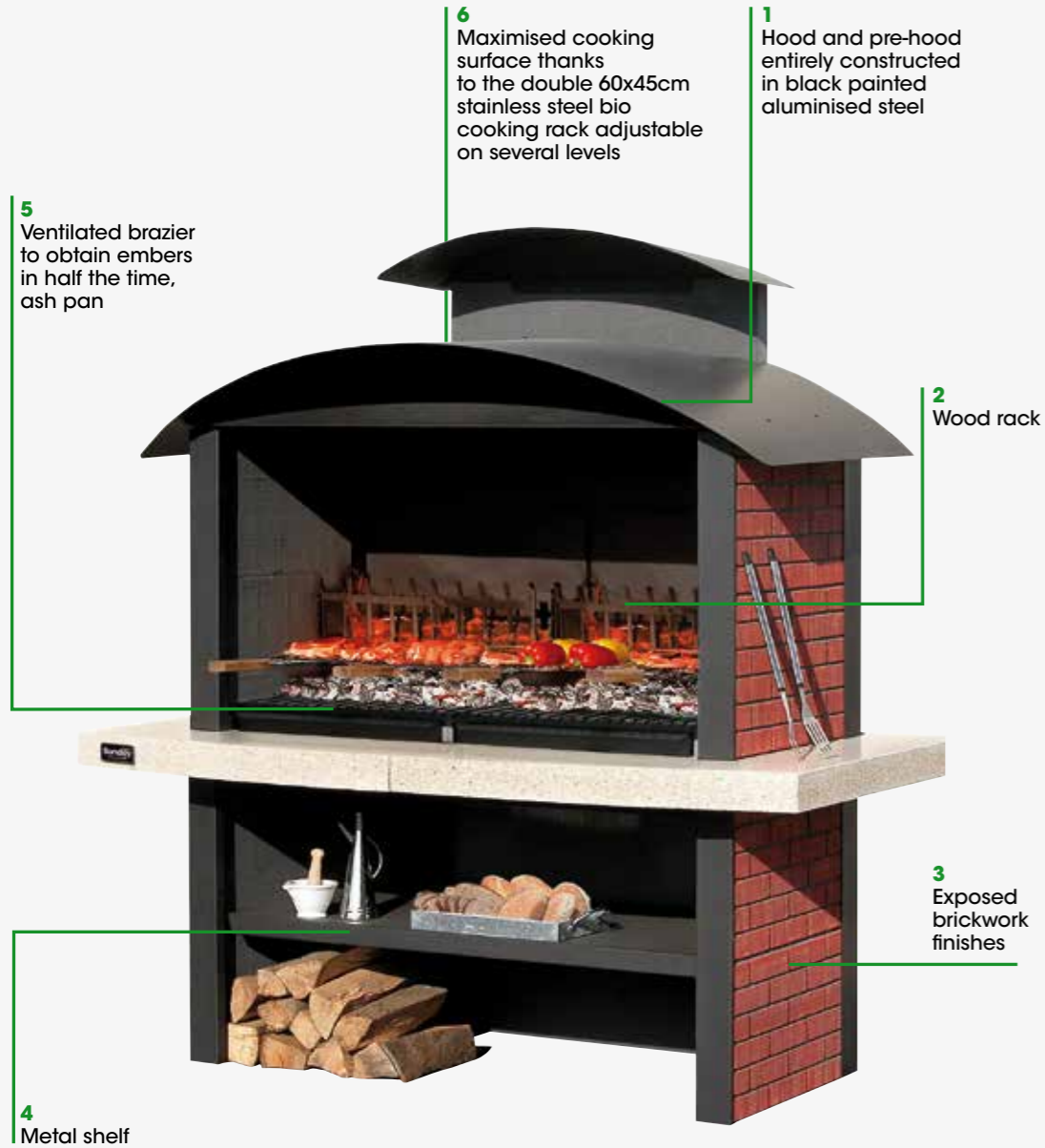

- Easy assembly with Betonfast (included)
- It uses wood and charcoal
- Smooth Crystal top
- Requires no painting
- Biologic stainless steel cooking rack

Barbecue in granulated marble with smooth Crystal top, black painted steel hood, sides with "Decor Brick" exposed brickwork finish, counter tops.
Code
 5710130

Cooking rack
 two 60x45cm bio
Servings
 14/16
Weight
 kg 1180
Packaging
 cm 120x105

- Recommended accessories**
- > 4008010 Rotisserie Kit - 70cm
 - > 40180051 Serpentine marble plate - 40x30cm
 - > 4012053 Set of 5 stainless steel accessories

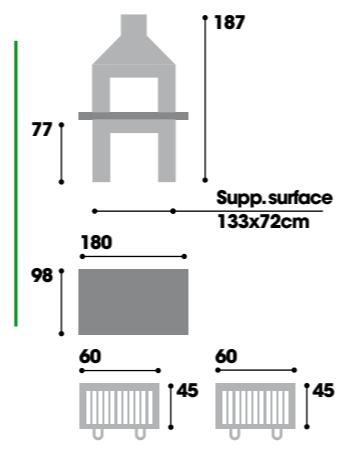
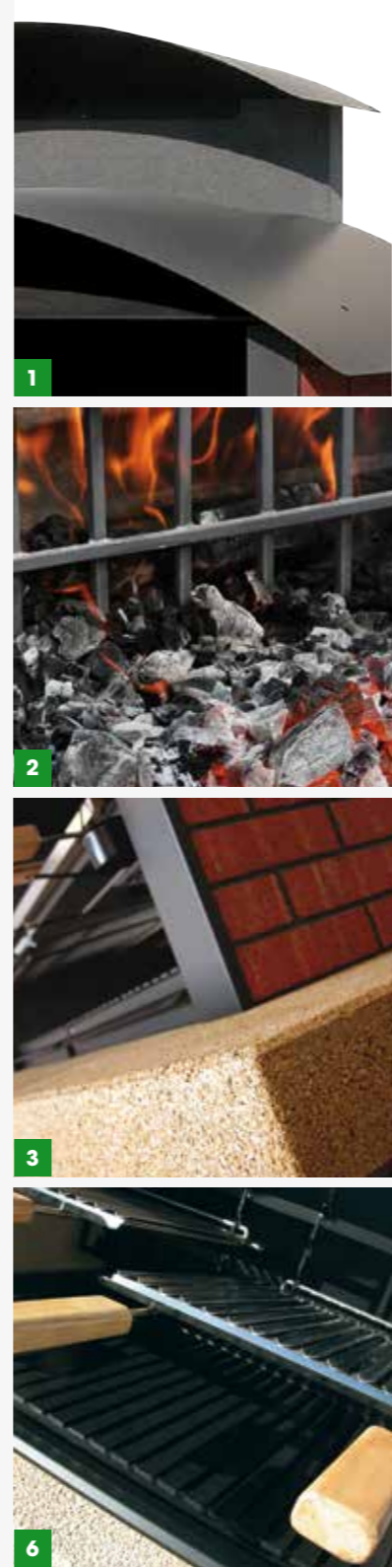

Colorado

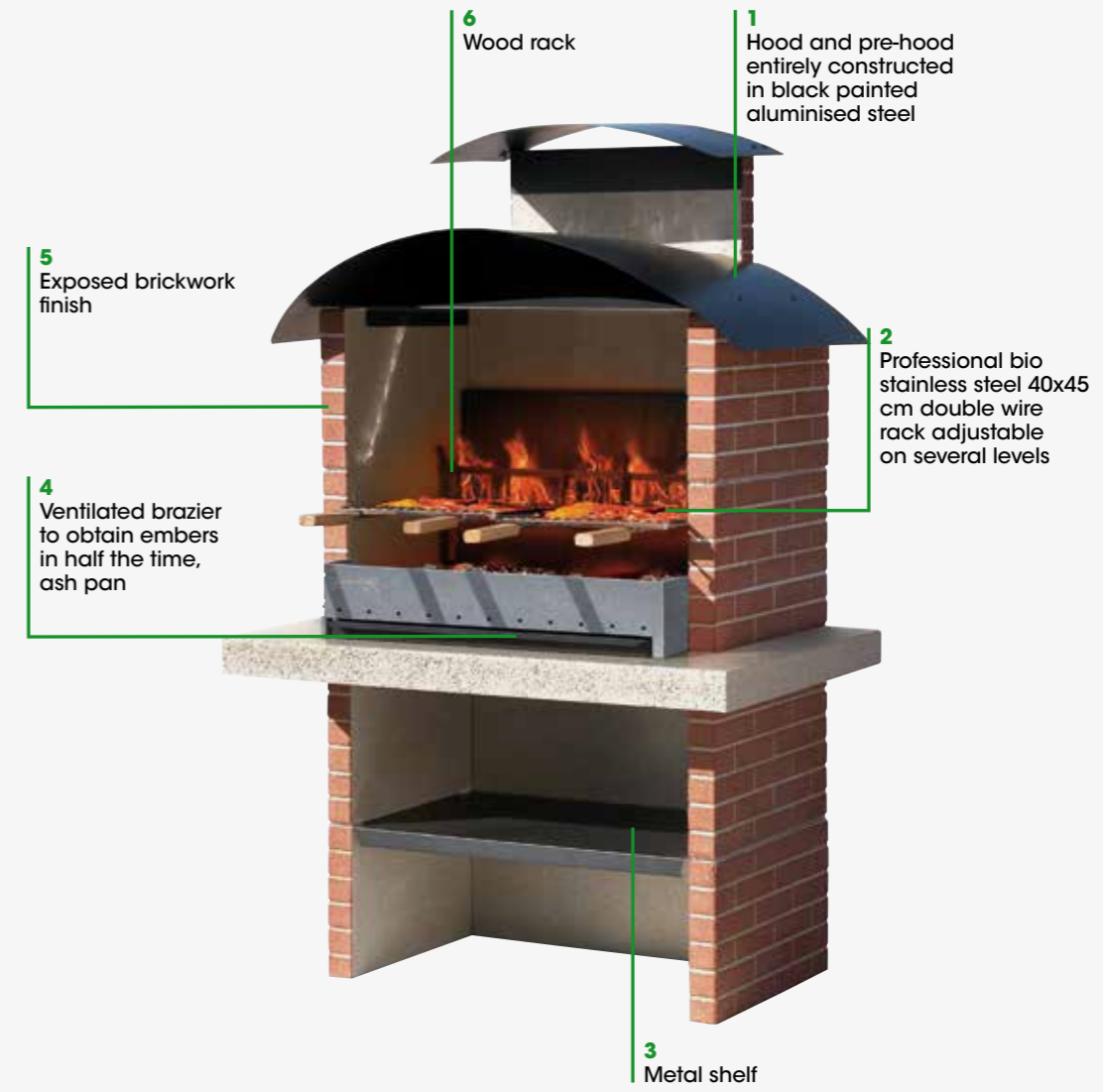

- Easy assembly with Betonfast (included)
- It uses wood and charcoal
- Smooth Crystal top
- Requires no painting
- Biologic stainless steel cooking rack

Granulated marble barbecue with smooth Crystal top, black painted steel hood, sides with "Decor Brick" exposed brickwork finish, wide counter tops.
Code
 5710132

Cooking rack
 two 40x45cm bio
Servings
 10/12
Weight
 kg 700
Packaging
 cm 80x120

- Recommended accessories**
- > 4008010 Rotisserie Kit - 70cm
 - > 4012055 Stainless Steel Multipurpose Spatula
 - > 4012053 Set of 5 stainless steel accessories

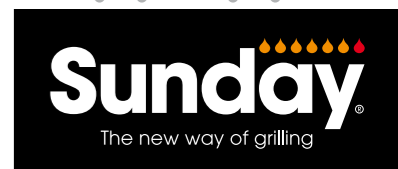
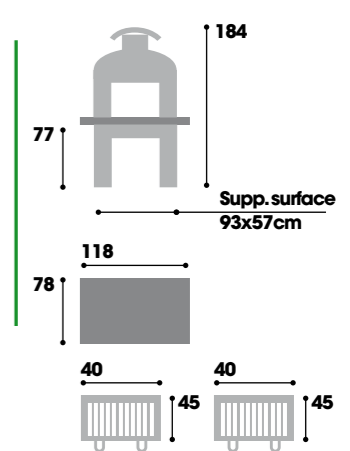



Tangeri

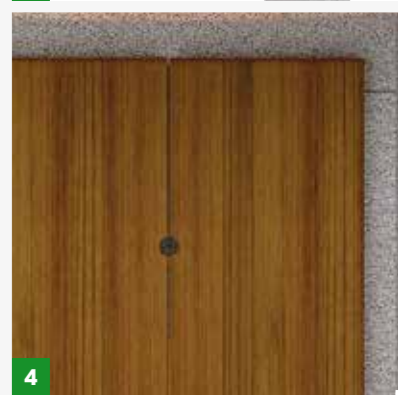
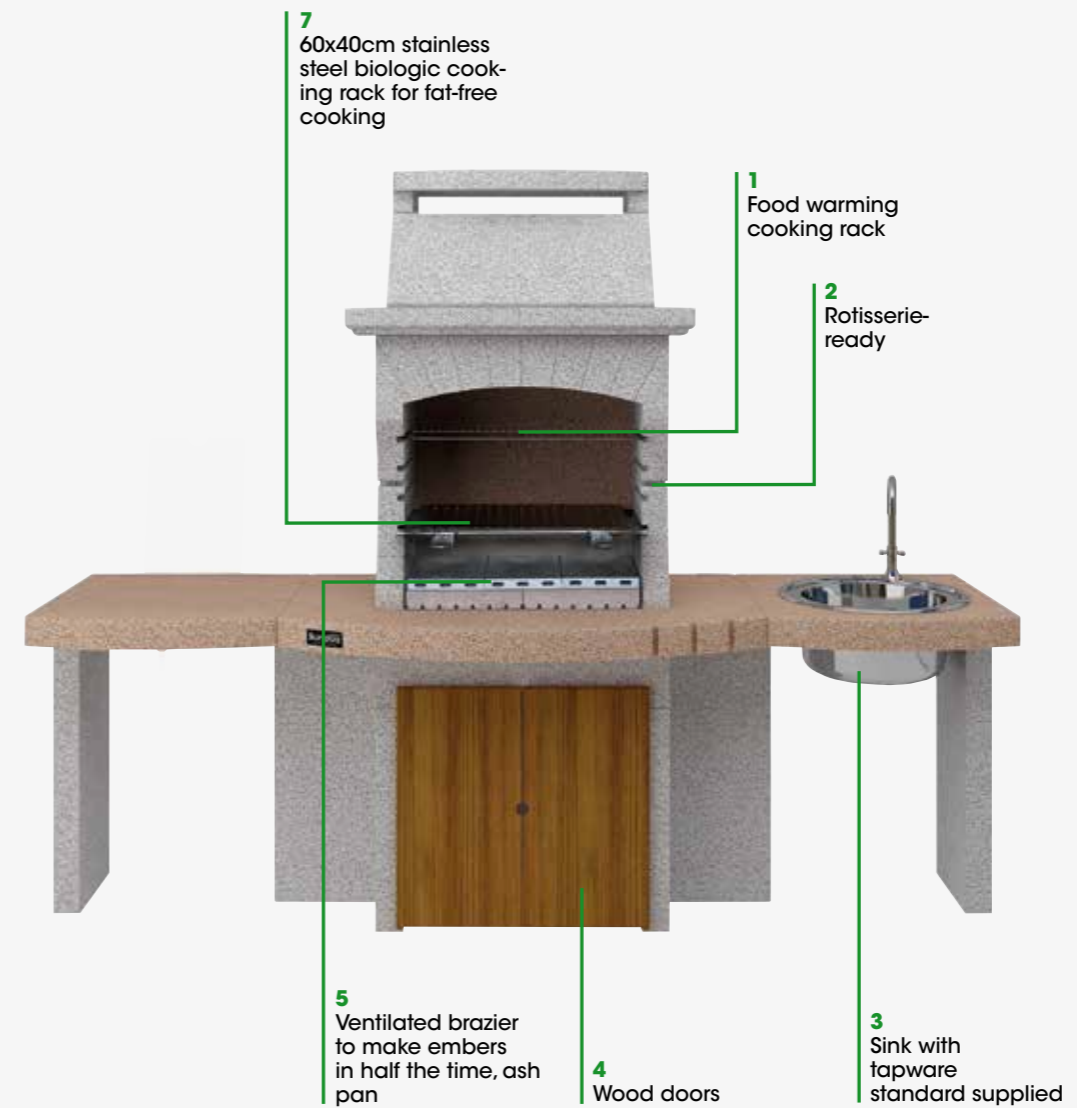

- Assembly with Betonfast
- It uses wood and charcoal
- Smooth Crystal top
- Requires no painting
- Biologic stainless steel cooking rack

Barbecue in granulated Asiago pink marble with smooth Crystal top, double side top fitted with sink and gas cooker, solid wood doors.

Code
5719001

Cooking rack
cm 60x40 bio
Servings
6/8
Weight
kg 720
Packaging
80x80cm

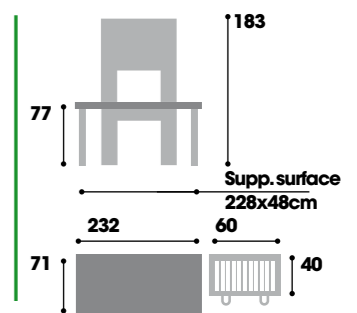

- Recommended accessories
- > 4008008 Rotisserie Kit - cm 56
 - > 40140154 Vertical wood rack brazier with feet - 55cm
 - > 40140177 Stealite steak griddle with handles - 60x40cm

- > 4012053 Set of 5 stainless steel accessories
- > 4009048 BBQ - XL Protective Cover
- > 4010070 BETONFAST adhesive® for BBQ assembly

Tebe Lx

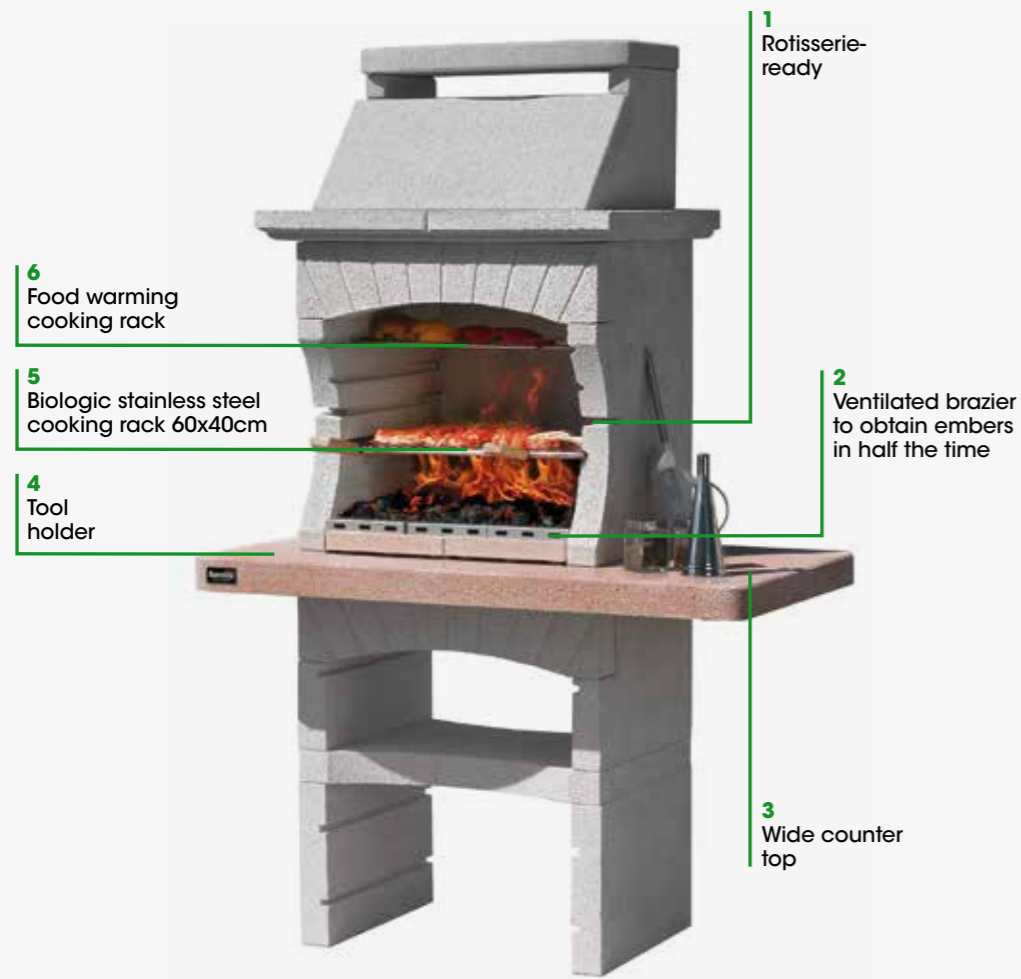

Djerba Lx

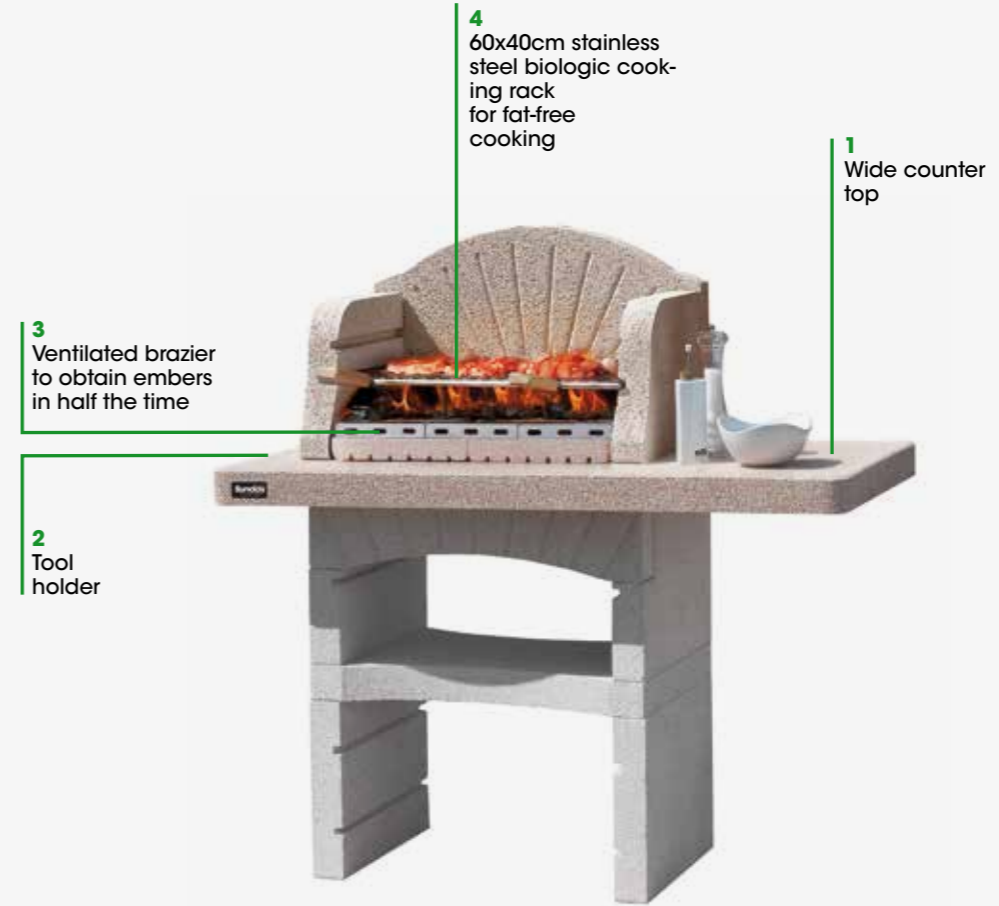

- Assembly with Betonfast
- It uses wood and charcoal
- Smooth Crystal top
- Requires no painting
- Biologic stainless steel cooking rack

Granulated marble barbecue, wide counter top in smooth Crystal finish.

Code
5710143

Cooking rack
cm 60x40 bio
Servings
6/8
Weight
kg 550
Packaging
82x60cm

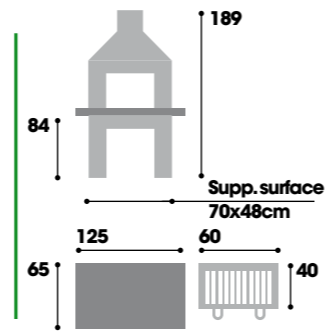

- Assembly with Betonfast
- It uses wood and charcoal
- Smooth Crystal top
- Requires no painting
- Biological stainless steel cooking rack

Granulated marble barbecue, wide counter top in smooth Crystal finish.

Code
5710142

Cooking rack
60x40cm bio
Places
6/8
Weight
kg 360
Packaging
82x60cm

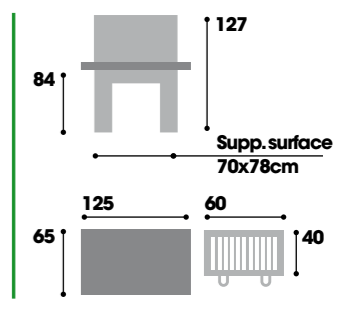

Recommended accessories

- > 4008055 Electric spit - 80cm
- > 40140177 Steatite steak griddle with handles - 60x40cm

- > 4012053 Set of 5 stainless steel accessories
- > 40180029 BBQ - M Protective Cover
- > 4010070 BETONFAST adhesive® for BBQ assembly

- > 4012053 Set of 5 stainless steel accessories
- > 4010070 BETONFAST adhesive® for BBQ installation

Dubai

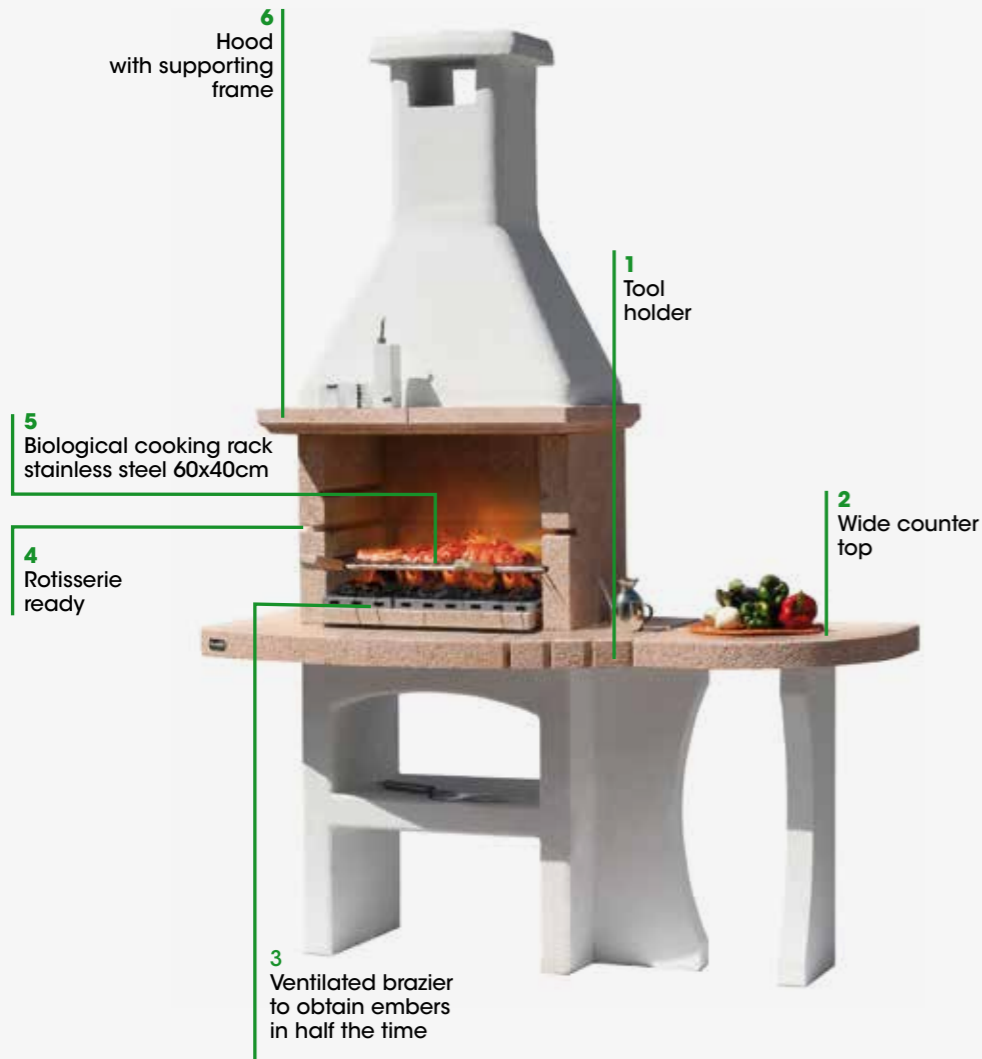

- Easy installation with Betonfast
- It uses wood and charcoal
- Smooth Crystal top
- Biologic stainless steel cooking rack

Barbecue in concrete and granulated marble with Asiago Pink working top and firebox; all tops in smooth Crystal finish.

Code
5710104B

Cooking rack
60x40cm bio
Servings
6/8
Weight
kg 560
Packaging
90x60cm

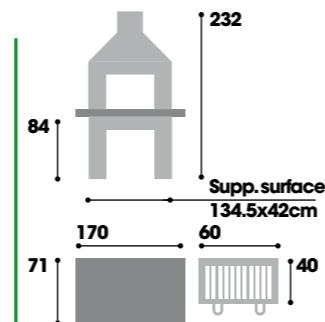

- Recommended accessories
- > 4008055 Electric spit - 80cm
 - > 40140177 Steatite steak griddle with handles - 60x40cm
 - > 4012053 Set of 5 stainless steel accessories

- > 4009047 BBQ - L Protective Cover
- > 4010070 BETONFAST adhesive® for BBQ assembly
- > 40180040 White BBQ paint - 10kg

Touareg

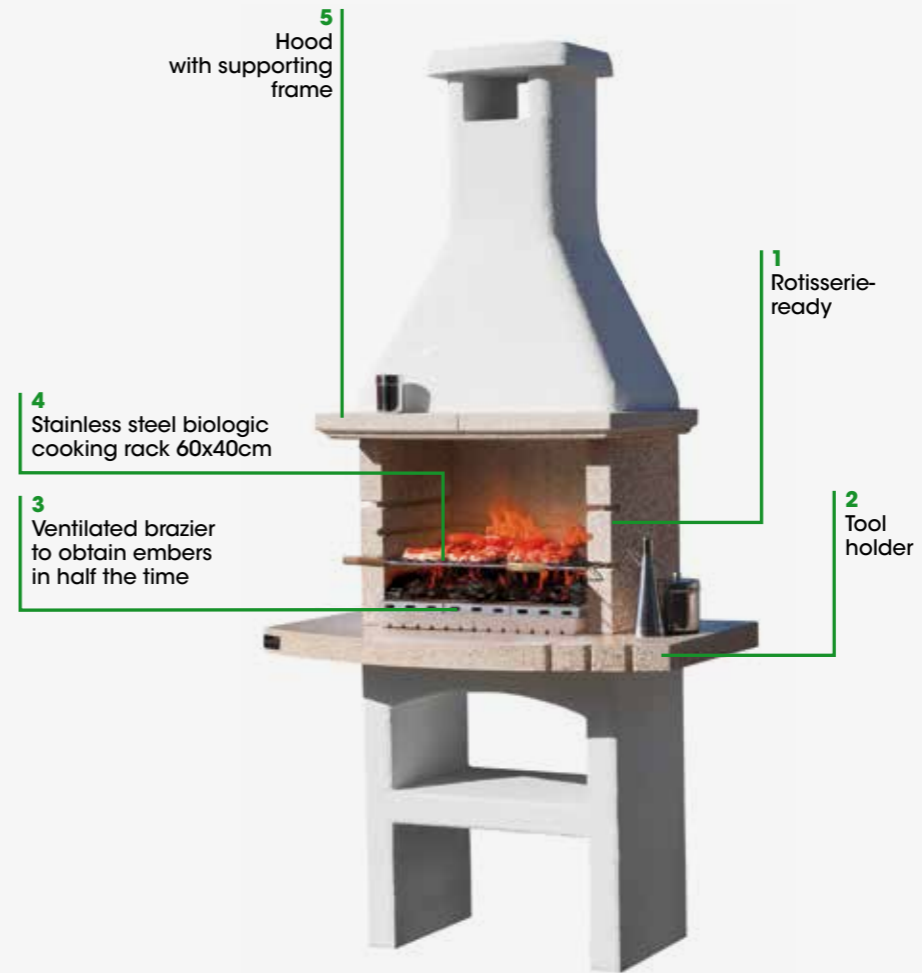

- Easy assembly with Betonfast
- It uses wood and charcoal
- Smooth Crystal top
- Biological stainless steel cooking rack

Barbecue in concrete and granulated marble with Asiago Pink working top and firebox, working top in smooth Crystal finish.

Code
5710103B

Cooking rack
cm 60x40 bio
Servings
6/8
Weight
kg 530
Packaging
82x60cm

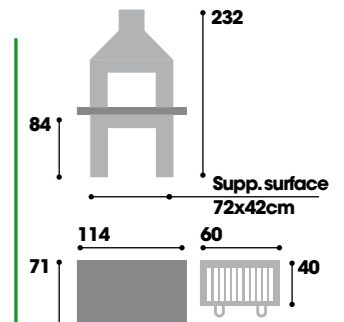

- Recommended accessories
- > 4008055 Electric spit - 80cm
 - > 40140177 Steatite steak griddle with handles - 60x40cm
 - > 4012053 Set of 5 stainless steel accessories

- > 40180029 BBQ - M Protective Cover
- > 4010070 BETONFAST adhesive® for BBQ assembly
- > 40180040 White BBQ paint - 10kg



Granada

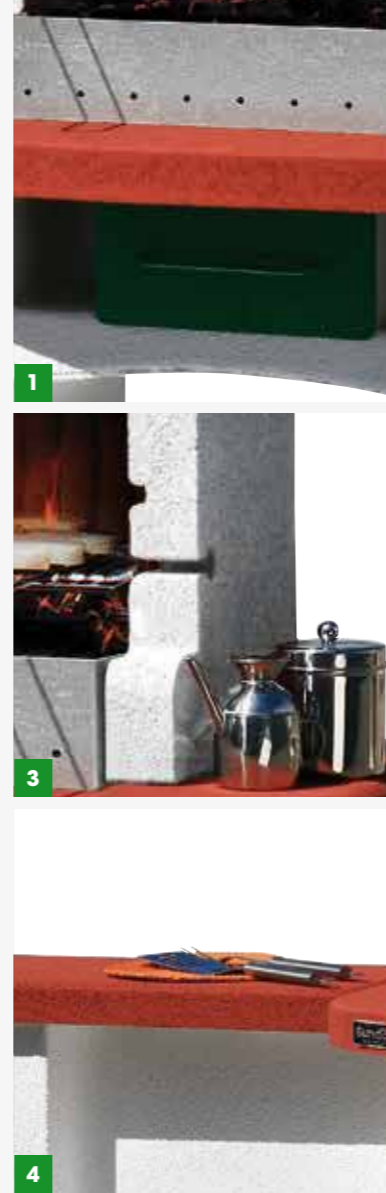
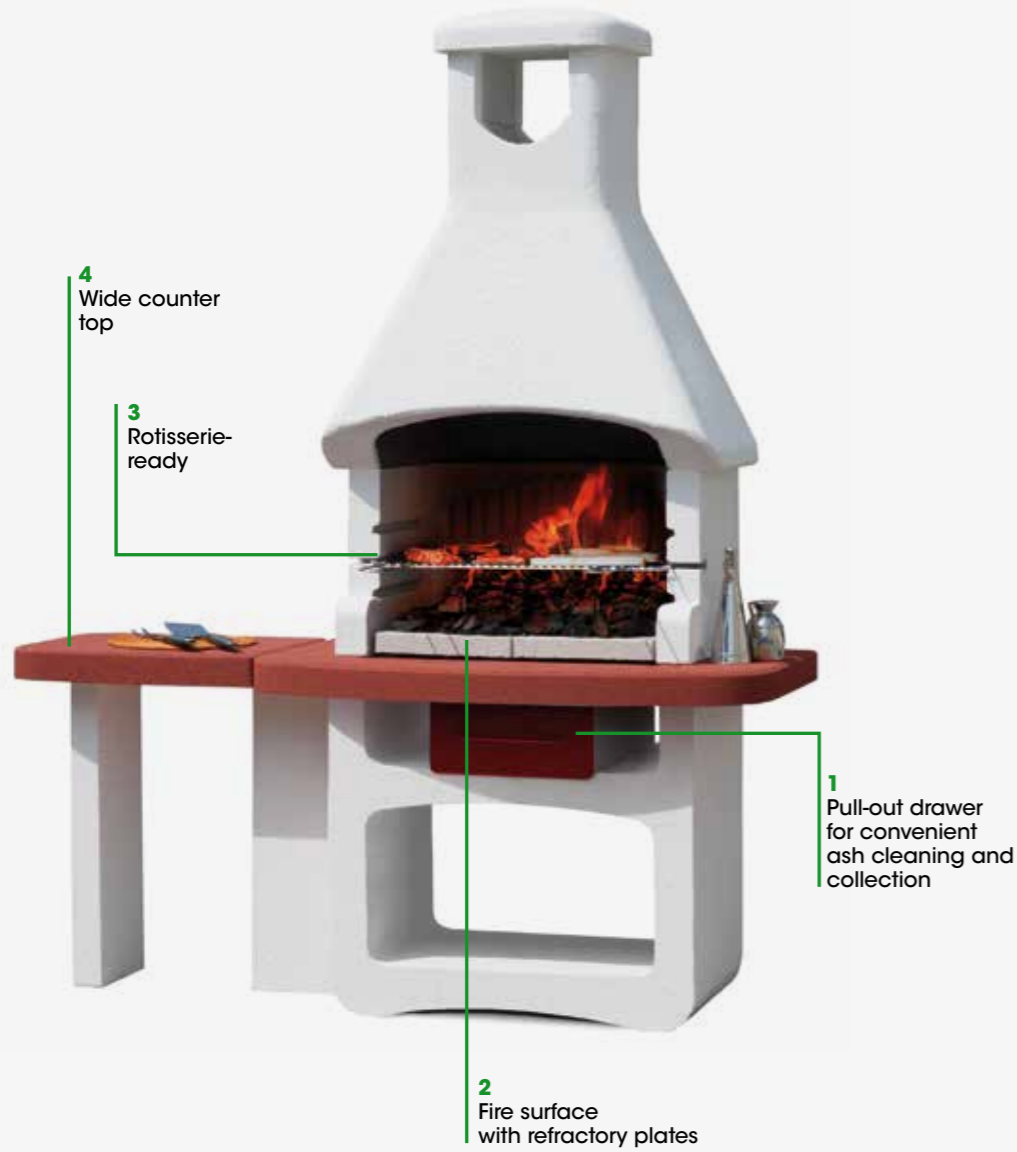

Assembly with Mortar

Only works with charcoal

Barbecue in concrete, pre-painted wide counter top and side top.

Code 57666

Cooking rack 67x40cm
 Servings 8/10
 Weight kg 530
 Packaging 95x60cm

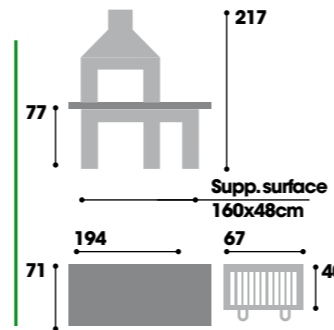

- Recommended accessories
- > 4008010 Rotisserie Kit - 70cm
 - > 40140178 Steatite steak griddle with handles - 67x40cm
 - > 4012053 Set of 5 stainless steel accessories

- > 4008077 Masonry BBQ counter-hood - Ø 20 / 67cm
- > 40180027 Mortar for BBQ assembly - 10kg
- > 40180084 Red BBQ paint - 1kg
- > 40180040 White BBQ paint - 10kg

Martinica Lx

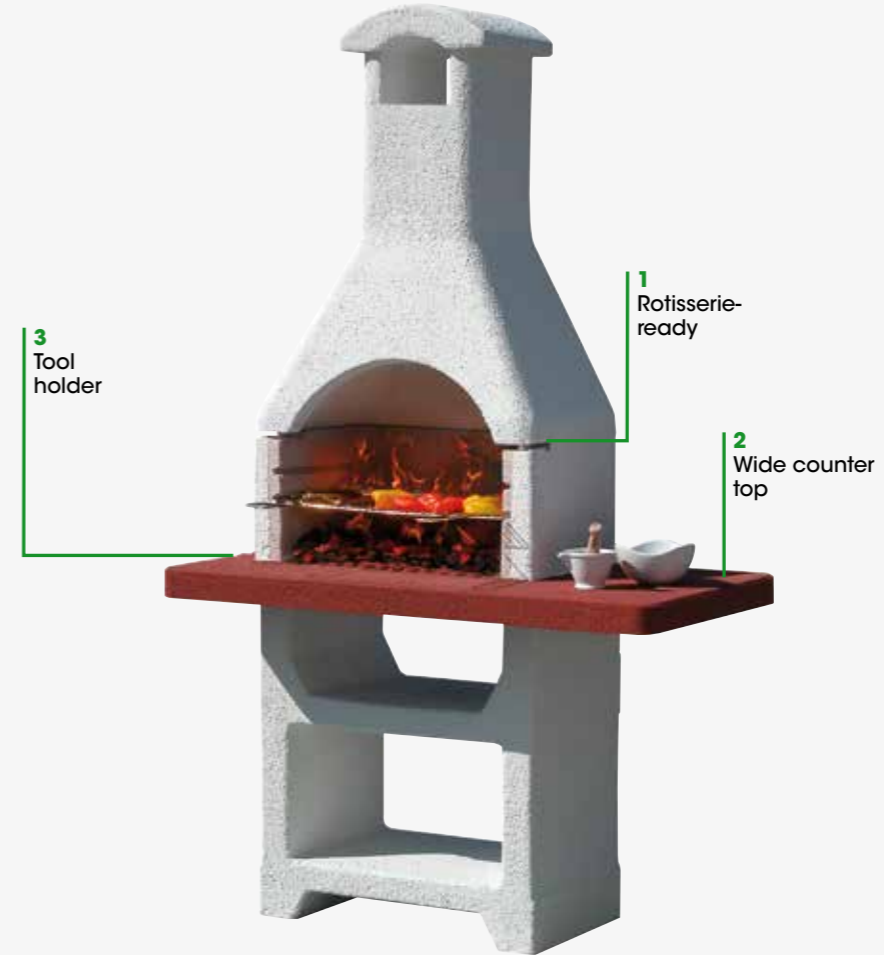

Assembly with Mortar

Only works with charcoal

Barbecue in concrete, pre-painted wide counter top and side top.

Code 57804

Cooking rack 60x40cm
 Servings 6/8
 Weight kg 307
 Packaging 75x60cm H.157

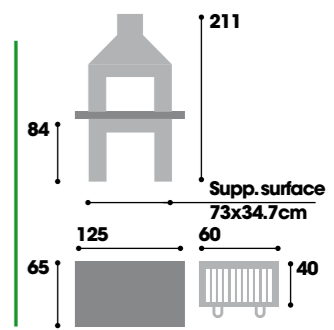

- Recommended accessories
- > 4008055 Electric spit - 80cm
 - > 4012031 Biologic Stainless Steel Cooking rack - 60x40cm
 - > 40140177 Steatite steak griddle with handles - 60x40cm

- > 4012053 Set of 5 stainless steel accessories
- > 40180029 BBQ - M Protective Cover
- > 40180040 White BBQ paint - 10kg

Metal BBQs.

The utmost convenience
and versatility of use matched
with the best cooking results,
guaranteed.





Texas 4

1
Double layer stainless steel lid for indirect cooking, with thermometer

2
Infra-red radiating panel 4 kW

7
Independent burners for overall power 12.6 kW

3
3.15 kW Side gas cooker for traditional cooking in pots

6
Internal gas cylinder compartment

5
Fat drip pan

4
Stainless steel cooking rack and hot plate

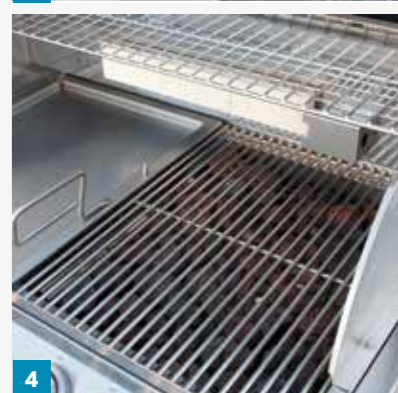
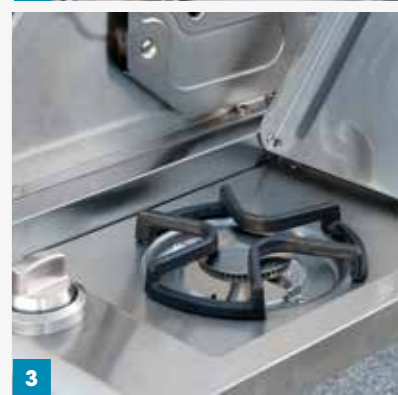

Stainless Steel
Cooking rack + Hot Plate



Stainless steel barbecue, four steel burners (12.6 kW), side cooker, radiating cooking rack, cupboard, wheels. Complete with stainless steel cooking rack and hot plate.
Code
5612003

Cooking rack
81x50cm
Servings
10/12
Power
12.6+3.15+4 kW
Weight
kg 72

Packaging
95x62x h 53cm
89x55x h 16cm

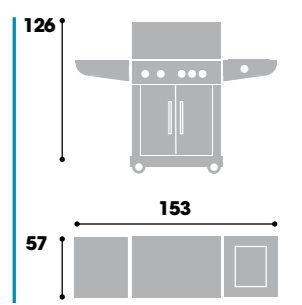

Recommended accessories
> 4008056 Electric spit - 100cm
> 4012055 Stainless Steel Multipurpose Spatula
> 4013025 Cooking rack and lava rock kit

> 4013027 Cooking rack
> 4012070 Stainless Steel Fork
> 4012057 Barbecue/Oven Glove
> 4010019 Apron

Texas 3



Stainless Steel
Cooking rack + Hot Plate

Stainless steel barbecue, three steel burners (9.6 kW), side cooker, cupboard, wheels. Complete with stainless steel cooking rack and hot plate.

Code
5613001

Cooking rack
60x50cm
Servings
8/10
Power
9.6+3.15 kW
Weight
kg 53

Packaging
79.5x59 h 53cm
79.5x46.5x h19.5cm

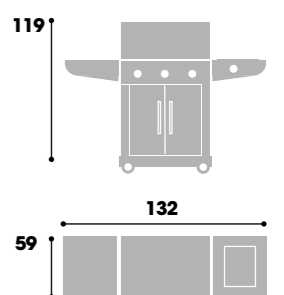

- Recommended accessories**
- > 4008055 Electric spit - 80 cm
 - > 4012055 Stainless Steel Multipurpose Spatula
 - > 4013025 Cooking rack and lava rock kit

- > 4013026 Cooking rack
- > 4012070 Stainless steel fork
- > 4012057 Barbecue/Oven Glove
- > 4010019 Apron

Montana 4



1 Double layer stainless steel lid for indirect cooking with thermometer

6 Counter top with tray

5 Separate burners with piezoelectric ignition for an overall power of 14 kW

4 Internal gas cylinder compartment

2 Side gas cooker 3.15 kW for traditional cooking in pots

3 Cast iron cooking rack + Hot Plate

Cast iron Cooking rack + Hot Plate

Stainless steel barbecue, four steel burners (14 kW), side cooker, cupboard, wheels. Complete with stainless steel cooking rack and cast iron hot plate.
Code
 5615002

Cooking rack
 cm 36x43 + 36x43
Servings
 10/12
Power
 14 + 3,15 kW
Weight
 kg 48

Packaging
 cm 82x62,5x h 64,5

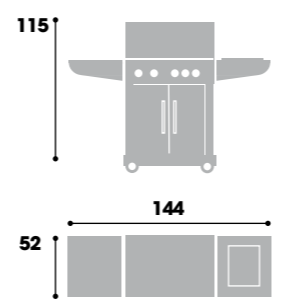

- Recommended accessories**
- > 4008056 Electric spit - cm 100
 - > 4012055 Stainless Steel Multipurpose Spatula
 - > 4015019 Cast iron hot plate cm 36x43

- > 4015020 Cast iron cooking rack cm 36x43
- > 4012070 Stainless steel fork
- > 4012057 Barbecue/Oven Glove
- > 4010019 Apron

Montana 3



1 Double layer stainless steel lid for indirect cooking with thermometer

6 Counter top

5 Separate burners with piezoelectric ignition for an overall power of 10,5 kW

4 Internal gas cylinder compartment

2 Side gas cooker 3.15 kW for traditional cooking in pots

3 Cast iron cooking rack + Hot Plate

Cast iron Cooking rack + Hot Plate

Stainless steel barbecue, three steel burners (10.5 kW), side cooker, cupboard, wheels. Complete with stainless steel cooking rack and cast iron hot plate.
Code
 5615001

Cooking rack
 Piastra cm 20.5x43 1 pz
 Griglia cm 20.5x43 2 pz
Servings
 8/10
Power
 10,5 + 3,15 kW
Weight
 kg 41

Packaging
 cm 72x62x h 64,5

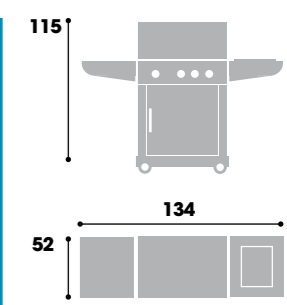

- Recommended accessories**
- > 4008055 Electric spit - cm 100
 - > 4012055 Stainless Steel Multipurpose Spatula
 - > 4015017 Cast iron hot plate cm 31x43

- > 4015018 Cast iron cooking rack cm 31x43
- > 4012070 Stainless steel fork
- > 4012057 Barbecue/Oven Glove
- > 4010019 Apron





Nevada Plancha



Enamelled plate

Stainless steel barbecue, three steel burners (9,45 kW), toolholder, wheels. Complete with Enamelled plate.

Code
5616001

Cooking rack
cm 62x40
Servings
7/8
Power
9,45 kW
Weight
kg 20

Packaging
cm 77x66 h 28

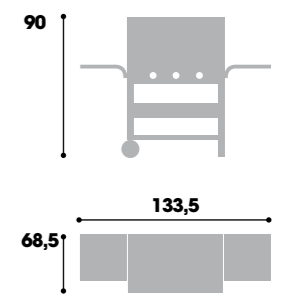

Recommended accessories
> 4012057 Barbecue/Oven Glove
> 4010019 Apron



Stainless Steel Profy 4



6
81.5x48.5
cooking surface
with 3 cooking
systems: cast iron
cooking rack with
lava rock, cast iron
hot plate and steatite

7
Stainless steel lid
for indirect cooking
with thermometer

1
Adjustable
side tops
to occupy less space

5
Independent
burners for overall
power
16 kW

4
Fat
drip pan

2
Tool
holder hooks

3
Gas cylinder
cover

Gas + Lava rock Cast iron cooking rack + Hot plate Steatite

Barbecue in black painted steel, four burners for 16 kW power, combined cooking (lava rock cooking rack+ hot plate + stone), wheels.

Code
5609015

Cooking rack
81.5x48.5cm
Servings
10/12
Power
16 kW
Weight
kg 52,5

Cooking rack Pack-aging
86x58x h 32.5cm
Cart Pack-aging
103x50x h 10cm

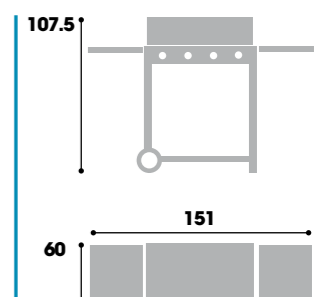

Recommended accessories
> 4011047 Cast iron hot plate for Profy series
> 4011048 Cast iron grill for Profy series
> 400022 Lava rock package - 3kg

> 4012054 Set of 3 stainless steel accessories
> 4012055 Stainless Steel Multipurpose Spatula
> 4012070 Stainless Steel Fork



Stainless Steel Profy 3

- 6** Double 65x48.5 cooking surface cast iron cooking rack with lava rock and cast iron hot plate
- 7** Stainless steel lid for indirect cooking with thermometer
- 1** Foldaway side tops to take up less space

- 5** Independent burners for overall power 12 kW
- 4** Gas cylinder cover
- 2** Tool holder hooks
- 3** Fat drip pan

Gas + Lava rock Cast iron cooking rack + Hot plate

Barbecue with stainless steel lid, fitted with 3 cast iron burners (12 kw), combined cooking (lava rock cooking rack + hot plate), wheels
Code
 56435

Cooking rack
 65x48.5cm
Servings
 8/10
Power
 12 kW
Weight
 kg 43

Cooking rack Packaging
 69.5x58x h 32.5cm
Cart Packaging
 87x50x h 10cm

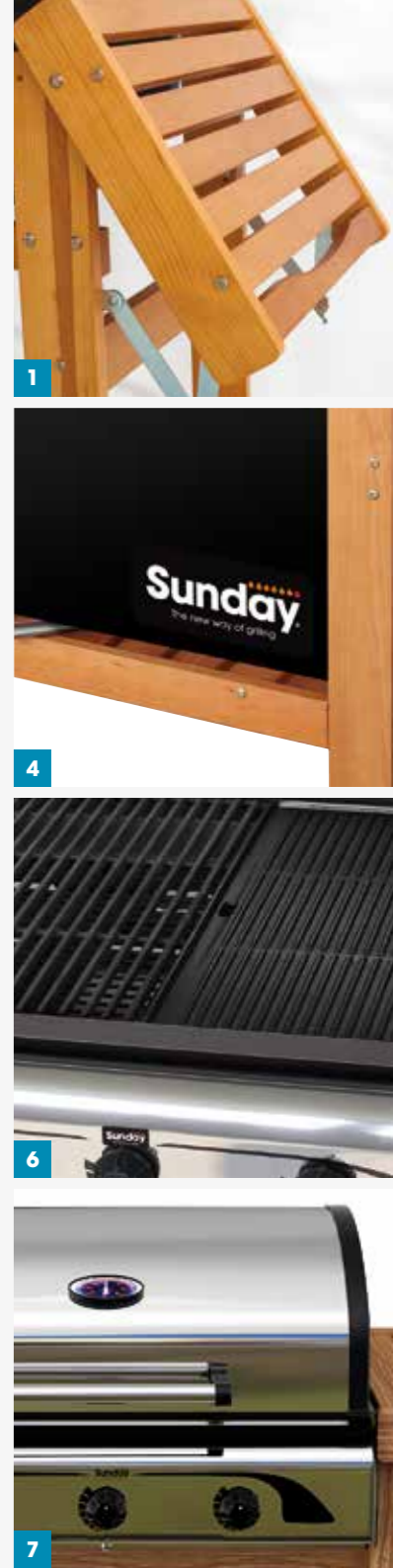
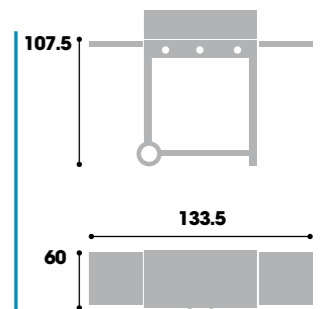

Recommended accessories

- > 400036 Cast iron hot plate for Profy and Master series - 32.5x48.5cm
- > 400037 Cast iron hot plate for Profy and Master series - 32.5x48.5cm

- > 400046 Support rack for lava rock
- > 400022 Lava rock package - 3kg
- > 4012055 Stainless Steel Multipurpose Spatula
- > 4012070 Stainless Steel Fork



Stainless Steel Master 4

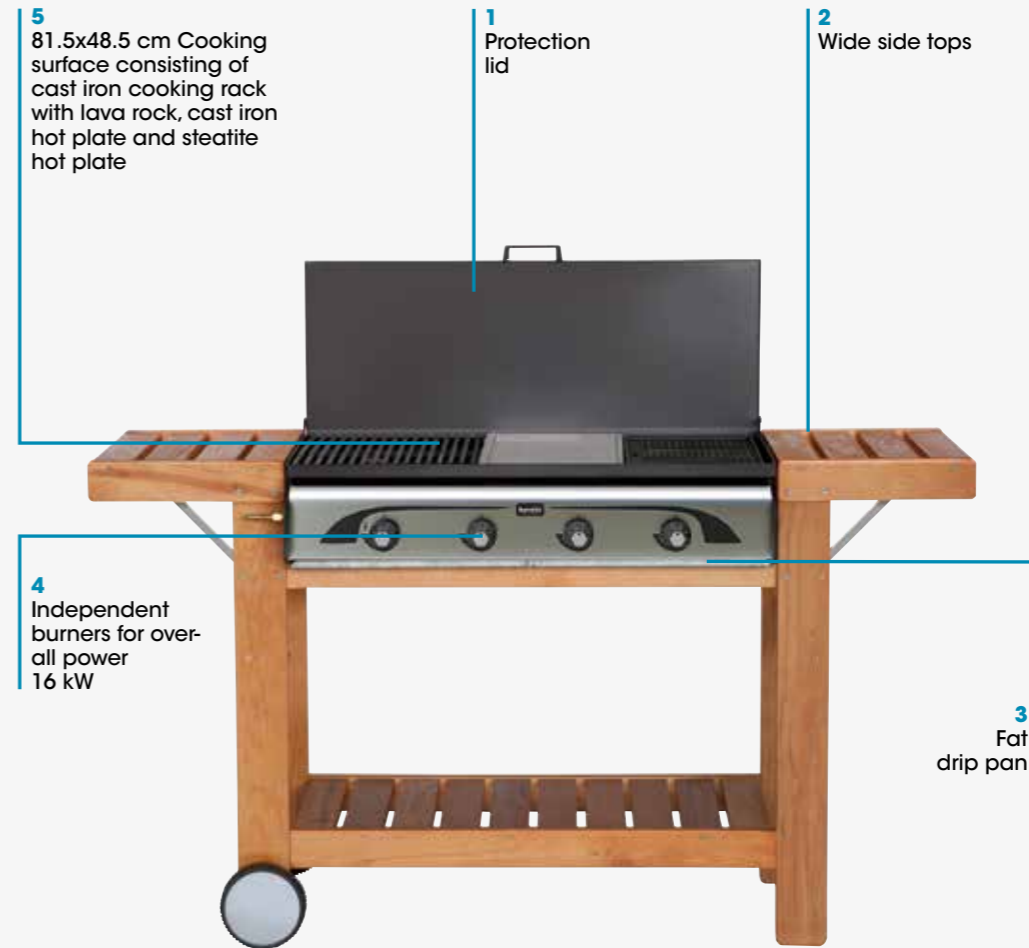

Gas + Lava rock Stainless Steel Cooking rack + Hot Plate

Barbecue in steel and wood, four burners for 16 kW power, combined cooking (lava rock cooking rack+ hot plate + stone), wheels.

Code
5609011

Cooking rack
81.5x48.5cm
Servings
10/12
Power
16 kW
Weight
kg 48,5

Cooking rack Packaging
85.5x58x h 22.5cm
Cart Packaging
103x50x h 10cm

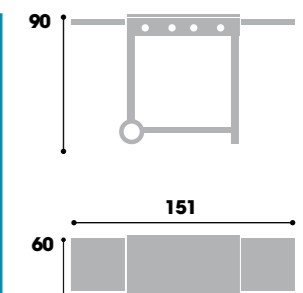

Recommended accessories

- > 400037 Cast iron hot plate for Profy and Master series - 32.5x48.5cm
- > 400038 Cast iron hot plate - 24.5x48.5cm

- > 400022 Lava rock package - 3kg
- > 4012055 Stainless Steel Multipurpose Spatula
- > 4012070 Stainless Steel Fork

Stainless Steel Master 3

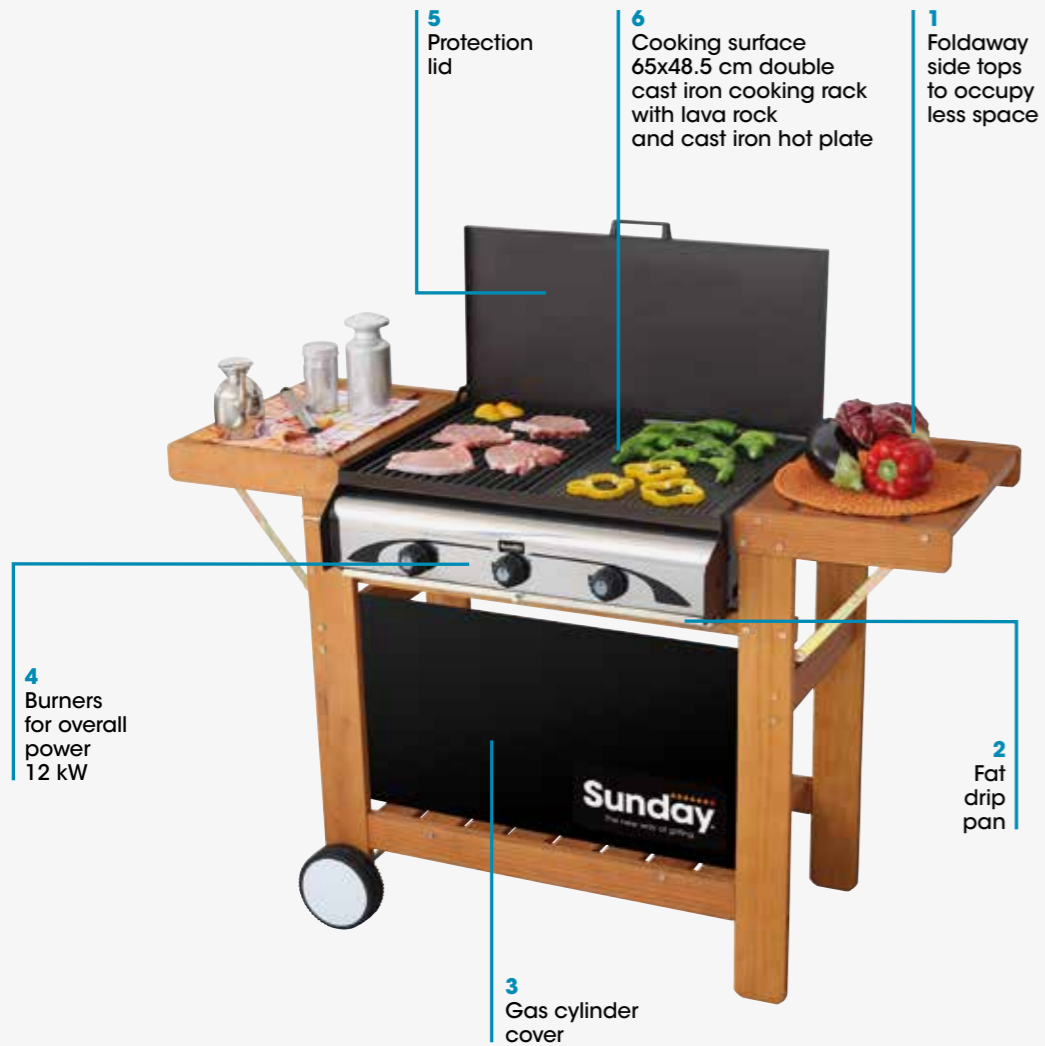

Gas + Lava rock

Cast iron cooking rack + Hot plate

Barbecue in black painted and stainless steel, three burners with 12 kW power, combined cooking (lava rock cooking rack + hot plate), wheels.
Code 5609009

Cooking rack
65x48.5cm
Servings 8/10
Power 12 kW
Weight kg 40

Cooking rack Packaging
69.5x58x h 22.5cm
Cart Packaging
87x50x h 10cm

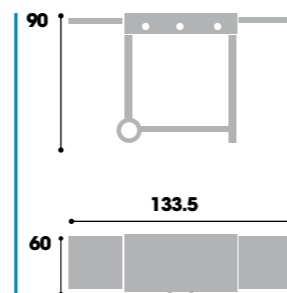

- Recommended accessories**
- > 400036 Cast iron hot plate for Profy and Master series - 32.5x48.5cm
 - > 400037 Cast iron hot plate for Profy and Master series - 32.5x48.5cm

- > 400022 Lava rock package - 3kg
- > 4012055 Stainless Steel Multipurpose Spatula
- > 4012070 Stainless Steel Fork

Master 2



Gas + Lava rock

Cast iron cooking rack + Hot plate

Barbecue in steel and wood, two burners with 8 kW power, combined cooking (lava rock cooking rack + hot plate), wheels.
Code 56523

Cooking rack
48.5x48.5cm
Servings 6/8
Power 8 kW
Weight kg 32

Cooking rack Packaging
58x53x h 22.5cm
Cart Packaging
85x50x h 10cm

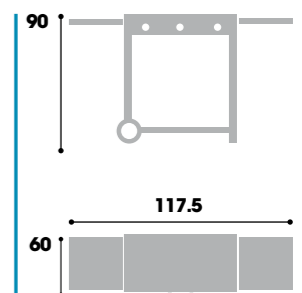

- Recommended accessories**
- > 400038 Cast iron hot plate - 24.5x48.5cm
 - > 400039 Cast iron cooking rack - 24.5x48.5cm

- > 4012055 Stainless Steel Multipurpose Spatula
- > 4012070 Stainless Steel Fork





Stainless Steel Dragon 80

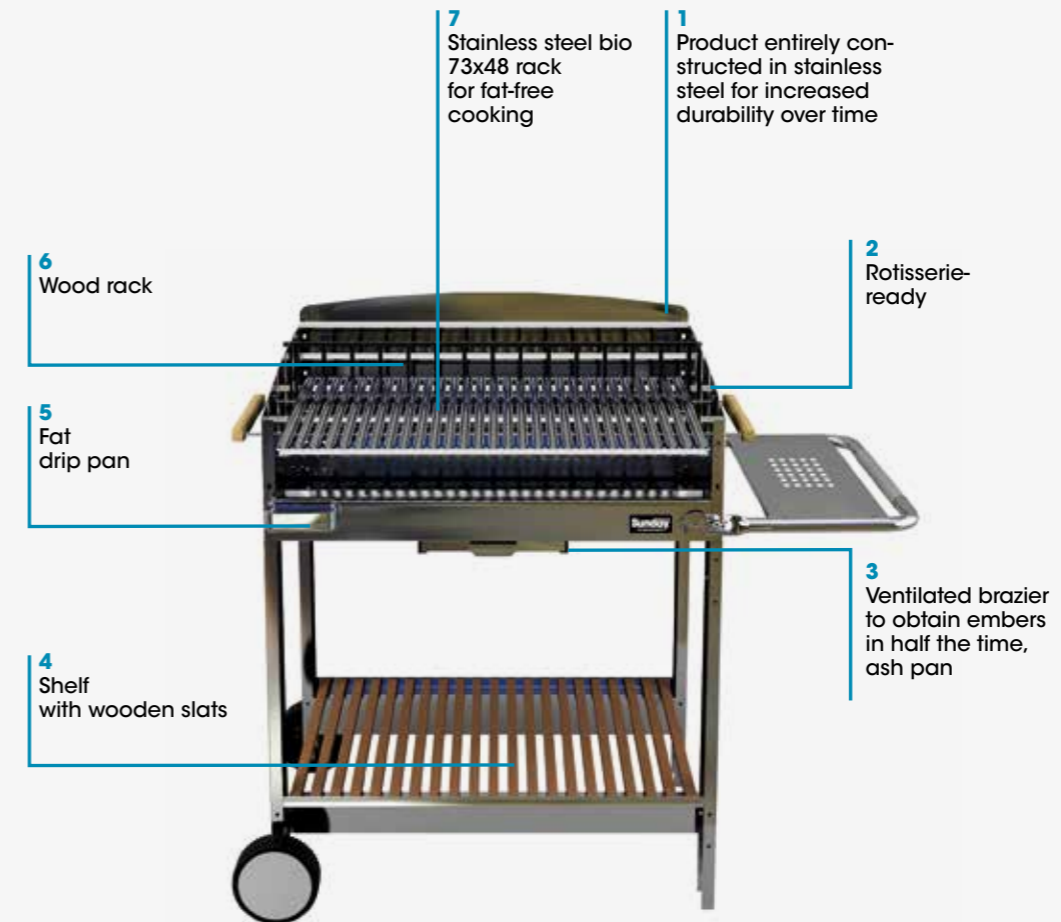

It uses wood and charcoal



Stainless steel barbecue with wood rack, counter tops.

Code
5609018

Cooking rack
72x45cm
Servings
10/12
Weight
kg 31,5
Packaging
93.5x61.5x h16cm

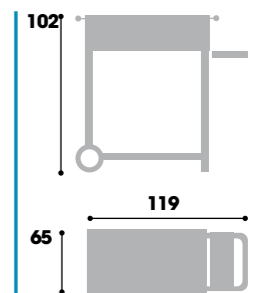

Recommended accessories
> 4012055 Stainless Steel Multipurpose Spatula
> 4012070 Stainless Steel Fork

> 4012057 Barbecue/Oven Glove
> 4010019 Apron



Stainless Steel Dragon 60

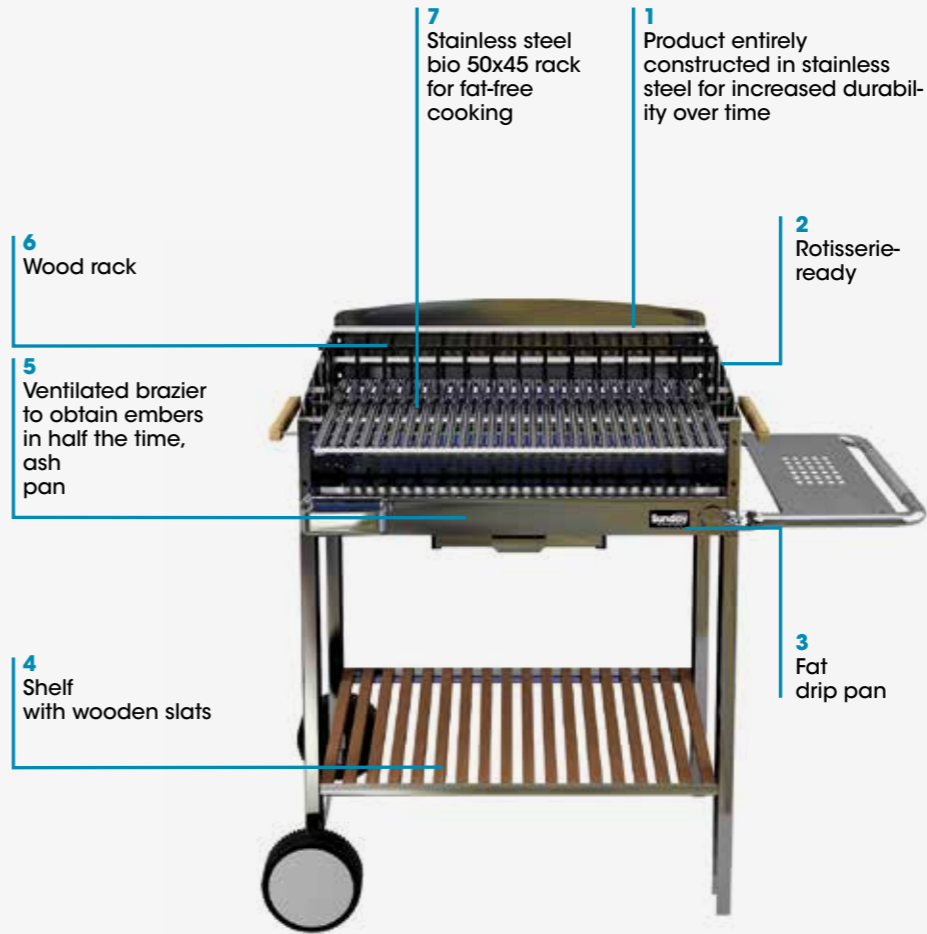

It uses wood and charcoal

Stainless steel barbecue with counter tops and wood rack.

Code
5608025

Cooking rack
50x45cm
Servings
8/10
Weight
kg 23
Packaging
93x50x h 15cm

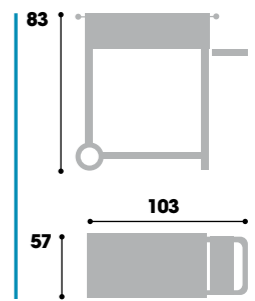

Recommended accessories
> 4012055 Stainless Steel Multipurpose Spatula
> 4012070 Stainless Steel Fork

> 4012057 Barbecue/Oven Glove
> 4010019 Apron



Apollo 100

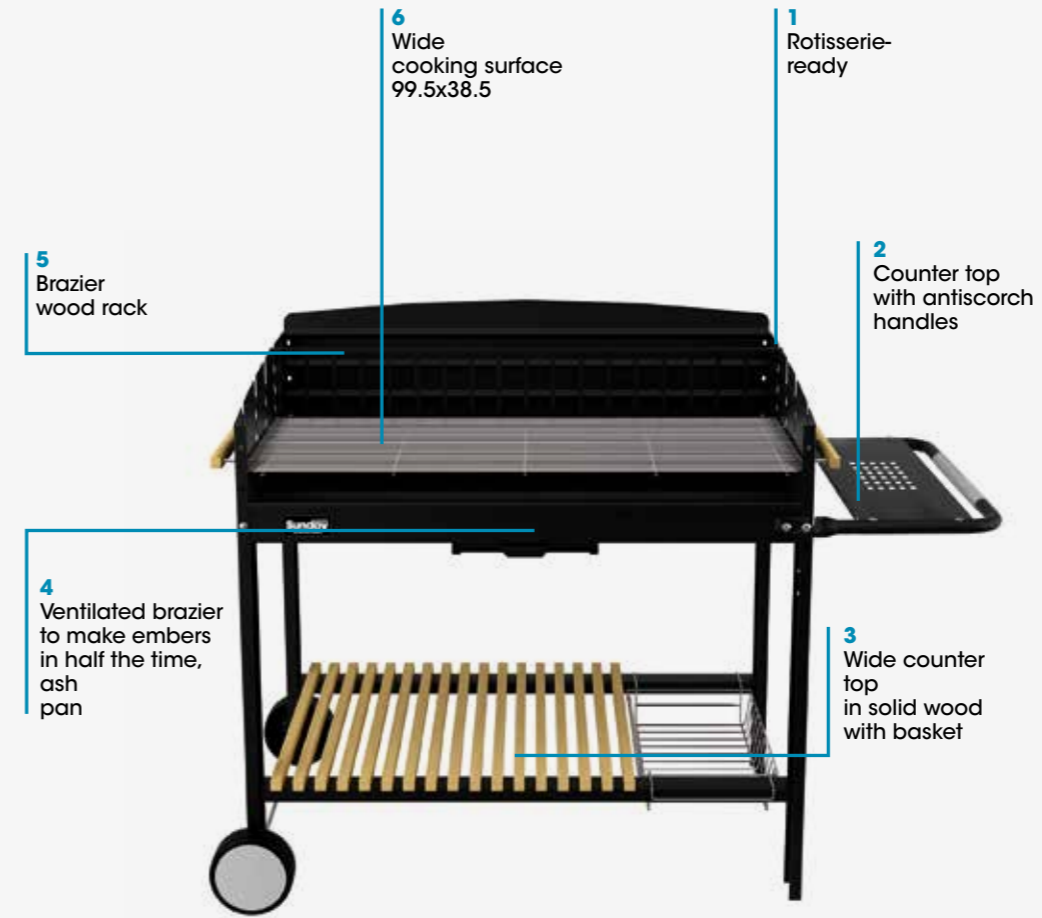

It uses wood and charcoal

Barbecue in painted steel with wood rack, counter tops.

Code
5608015

Cooking rack
99.5x38.5cm
Servings
12/14
Weight
kg 39
Packaging
114x58.5x h 13.5cm

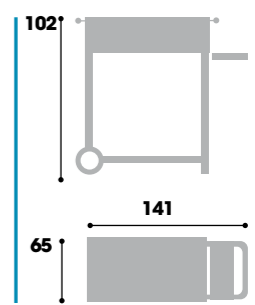

Recommended accessories
> 4012055 Stainless Steel Multipurpose Spatula
> 4012070 Stainless Steel Fork

> 4012057 Barbecue/Oven Glove
> 4010019 Apron

Apollo 80



It uses wood and charcoal

Barbecue in painted steel with counter tops.

Code
5608024

Cooking rack
77x38.5cm
Servings
10/12
Weight
kg 31,7
Packaging
93x60.5x h 15.5cm

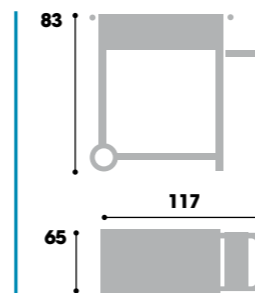

Apollo 60

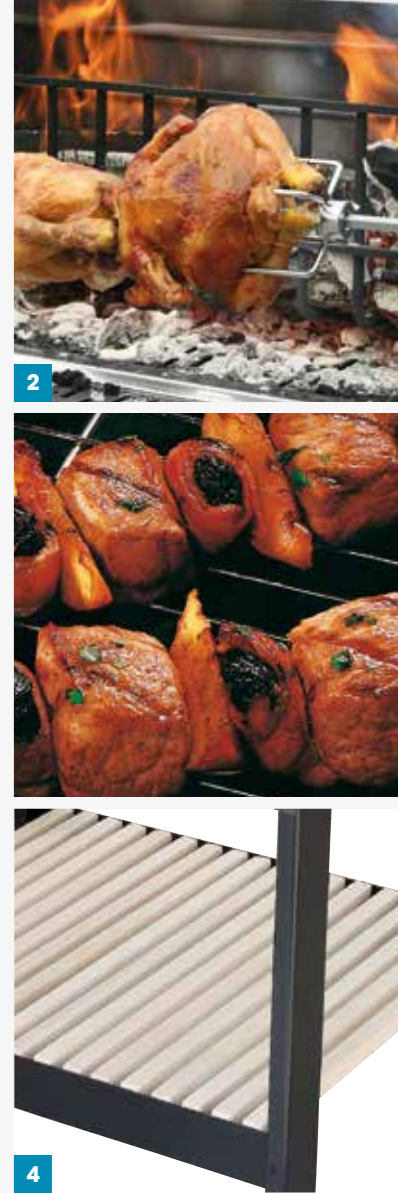

It uses wood and charcoal

Barbecue in painted steel with counter tops.

Code
5608023

Cooking rack
54.5x38.5cm
Servings
6/8
Weight
kg 26
Packaging
71x60.5x h 13.5cm

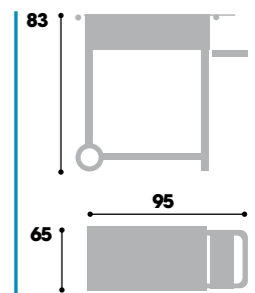

Recommended accessories
> 4012055 Stainless Steel Multipurpose Spatula
> 4012070 Stainless Steel Fork

> 4012057 Barbecue/Oven Glove
> 4010019 Apron

Recommended accessories
> 4012055 Stainless Steel Multipurpose Spatula
> 4012070 Stainless Steel Fork

> 4012057 Barbecue/Oven Glove
> 4010019 Apron

Metal ovens.



Why use the oven?

- 🔥 Conviviality and culinary pleasure.
- 🔥 Possibility to cook for many guests.
- 🔥 Cooking with no smells in the house.
- 🔥 Environmental friendliness and savings: cooking with Sunday ovens® is 10 times less expensive compared to an electric oven and 5 times less than a masonry oven.
- 🔥 Italian tradition with advanced cooking performance.



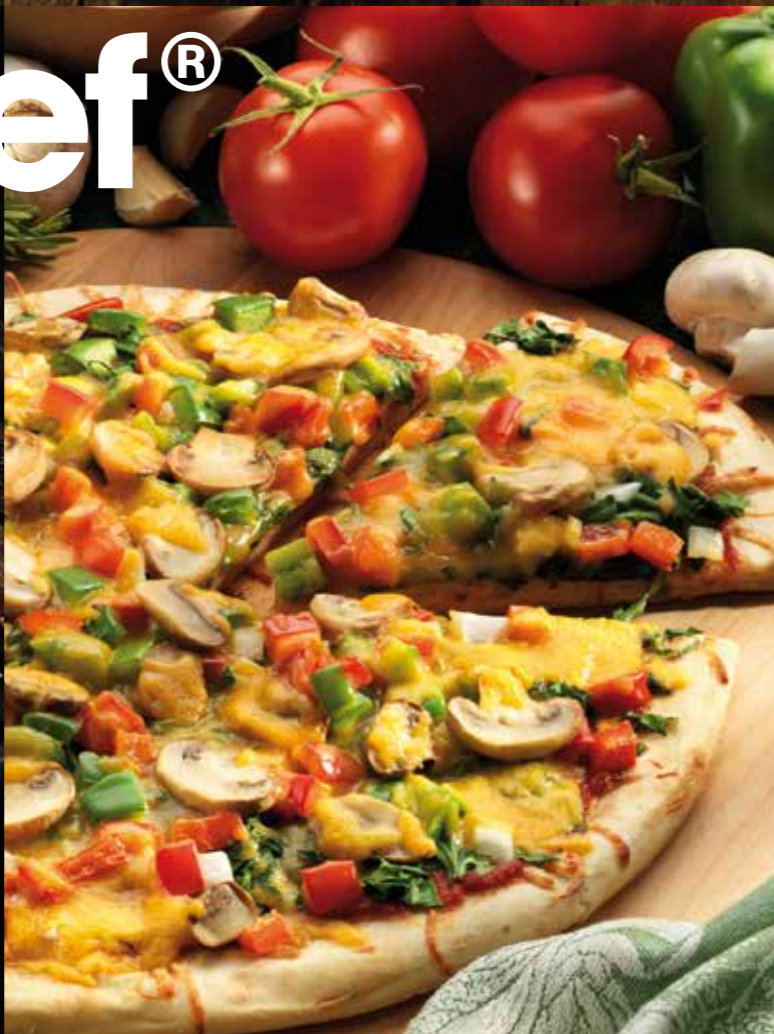

Perfect cooking with no smells being transferred between different dishes.



Sunday ovens[®], thanks to the exclusive cooking chamber technology and pyrolysis ventilation system, allow baking vapours to be abated, thus preventing smells being transferred between different dishes.

The enveloping radiant convection system, a refined Sunday solution[®], consistently distributes heat via the nozzles located in various parts of the oven.



Oven operation diagram

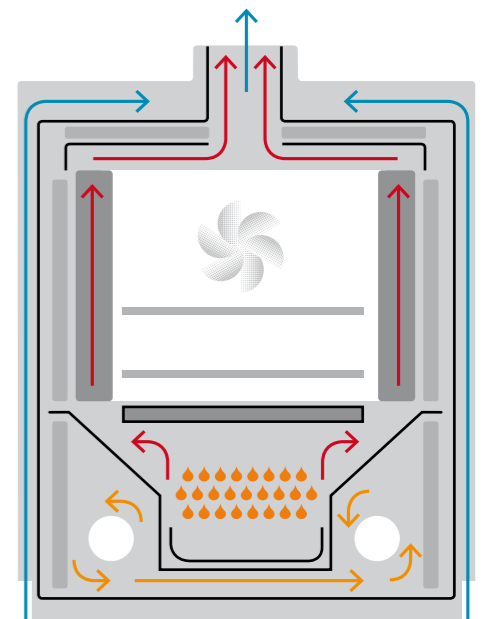

Cooking chamber

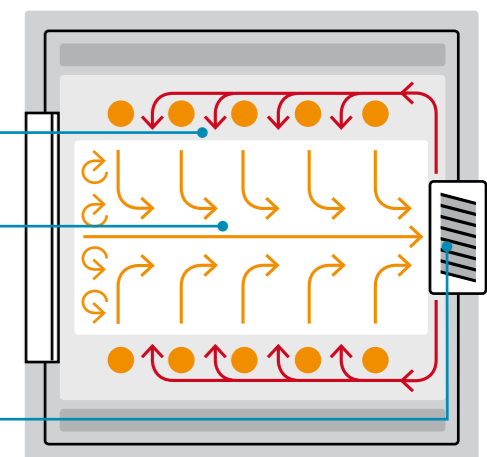

Cooking smoke and smells are eliminated thanks to pyrolysis, thus allowing various foods to be baked simultaneously.

Diffused heat for consistent baking.

The hot air is sucked in by the cooking chamber and conveyed through the side ducts.

1 Multichef[®]

2 AutoClean®



An exclusive system which keeps the oven cleaner.



Baking vapours and smoke are abated by a special pyrolytic system leaving the oven a lot cleaner compared to products available on the market. Moreover, the double glass which thermally insulates the heating and cooking chambers always stays cleaner. Finally, when oven cleaning is necessary, the operation is decidedly easier thanks to the possibility to completely remove all the walls of the cooking chamber, including the rear and top.

Less time for cleaning, more time for yourself!



Completely removable cooking chamber



Cooking chamber

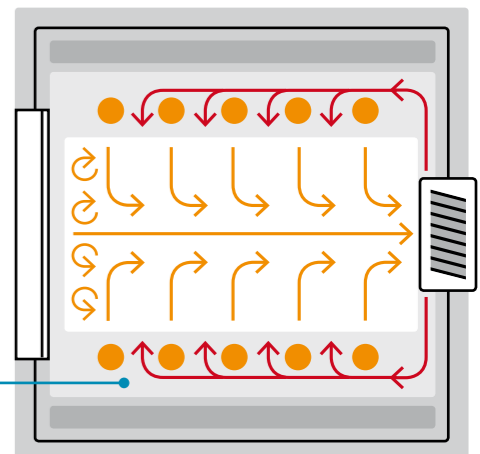

Baking steam and smoke is abated thanks to the pyrolytic system, leaving the cooking chamber cleaner.



3 Fireblade®

The heat does not escape when the door is opened.



Unlike what happens with traditional models, in Sunday ovens® the door may be opened, drastically limiting heat escape without needing to turn off the ventilation system.

Finally with Fireblade® the perfect soufflé is guaranteed.



Thermal break



Cooking chamber

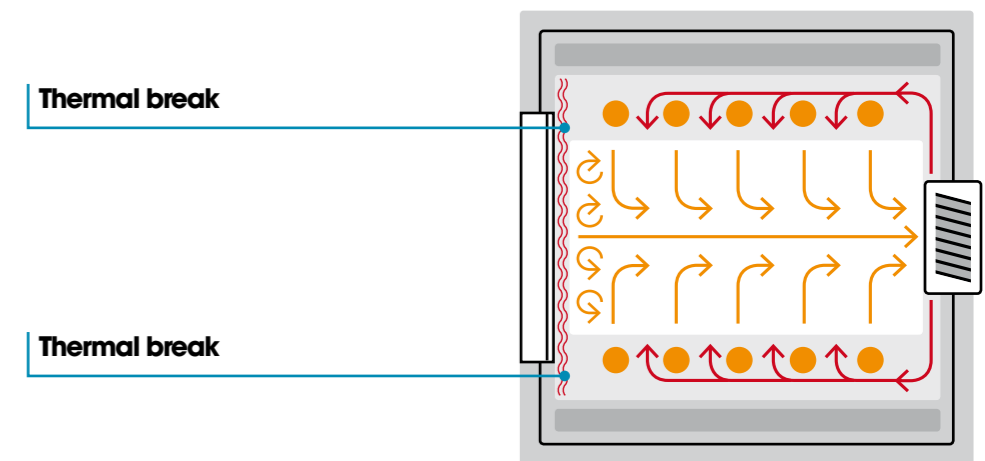

4 Comfort Air®

**From now on, the oven,
in addition to baking,
will also warm you.**



**Thanks to Comfort Air®,
the revolutionary system patented
by MCZ which gives you the
possibility to duct hot air up to
8 metres, while you are baking
with the oven, you can also heat
several rooms in your home.**

**Environmental friendliness and
savings
in heating expenses,
comfortable rooms.**



**Detail of the rear portion
of the oven compatible
with Comfort Air® system**

8-metre ducting

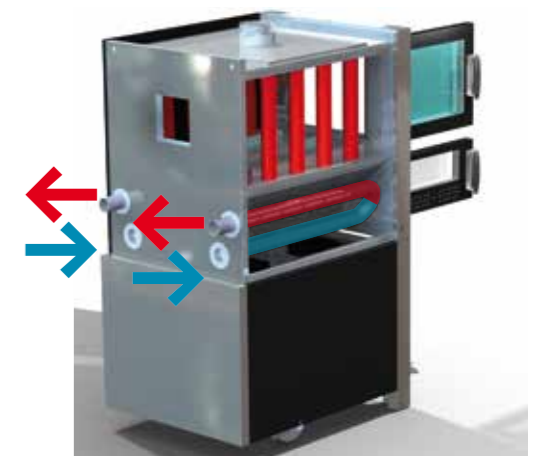



Double glazing 🔥🔥🔥

The double glazing in the cooking chamber and in the hearth are conducive to excellent thermal insulation and consequent savings. This feature also offers a high degree of protection and safety compared to the most widespread models on the market.

5



Refractory material surface 🔥🔥🔥

On all Sunday ovens,[®] the refractory material surface is standard supplied.

11



Baking steam adjustment 🔥🔥🔥

Anyone who cooks knows how important it is to be able to adjust the baking steam outlet: food baked to perfection, the crust on the roast, bread that does not shrink are the most common advantages. In order to guarantee these results, the Premium and Arcos models have been fitted with a suitable baking steam outlet adjustment valve at the front.

6



Air grid 🔥🔥🔥

Combustion is controllable via the adjustable air inlet grid.

12



Smoke adjustment 🔥🔥🔥

The exhaust smoke closing valve lets you maintain the heat inside the oven and, unlike most of the other ones, is located on the front for better more convenient use.

7



Instrumentation 🔥🔥🔥

Complete instrumentation with thermometer and timer.

13



Stainless steel door striker 🔥🔥🔥

In order to assure the best hygiene and facilitate cleaning, Sunday ovens[®] are fitted with a stainless steel door striker frame, completely preventing the risk of rusting.

8



Foldaway top 🔥🔥🔥

The oven cart (optional) is fitted with a convenient foldaway steel top, handy to support serving plates or oven trays.

14

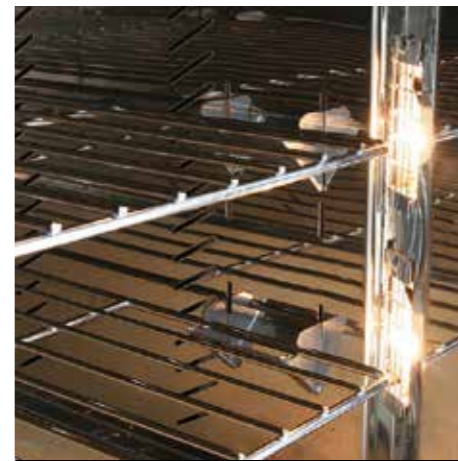

Stainless steel cooking chamber 🔥🔥🔥

To guarantee hygiene and longest-lasting efficiency, the 3-level cooking chamber is entirely constructed in precious AISI 304 BA stainless steel or 430 BA stainless steel. In Premium models, perfect lighting of the cooking chamber is assured by using two internal lamps located on the sides which emit a diffused, never unpleasant light.

9



Accessory 🔥🔥🔥

Three-year warranty. Complete terms in the warranty booklet.

15



Aluminised steel 🔥🔥🔥

In order to assure maximum weather resistance, the structure is entirely in aluminised steel and the exterior in stainless or powder painted steel.

10



Warranty 🔥🔥🔥

Sunday[®] ovens are abundantly outfitted as standard, including a square tray and two wire racks.

16



Premium 80

Premium

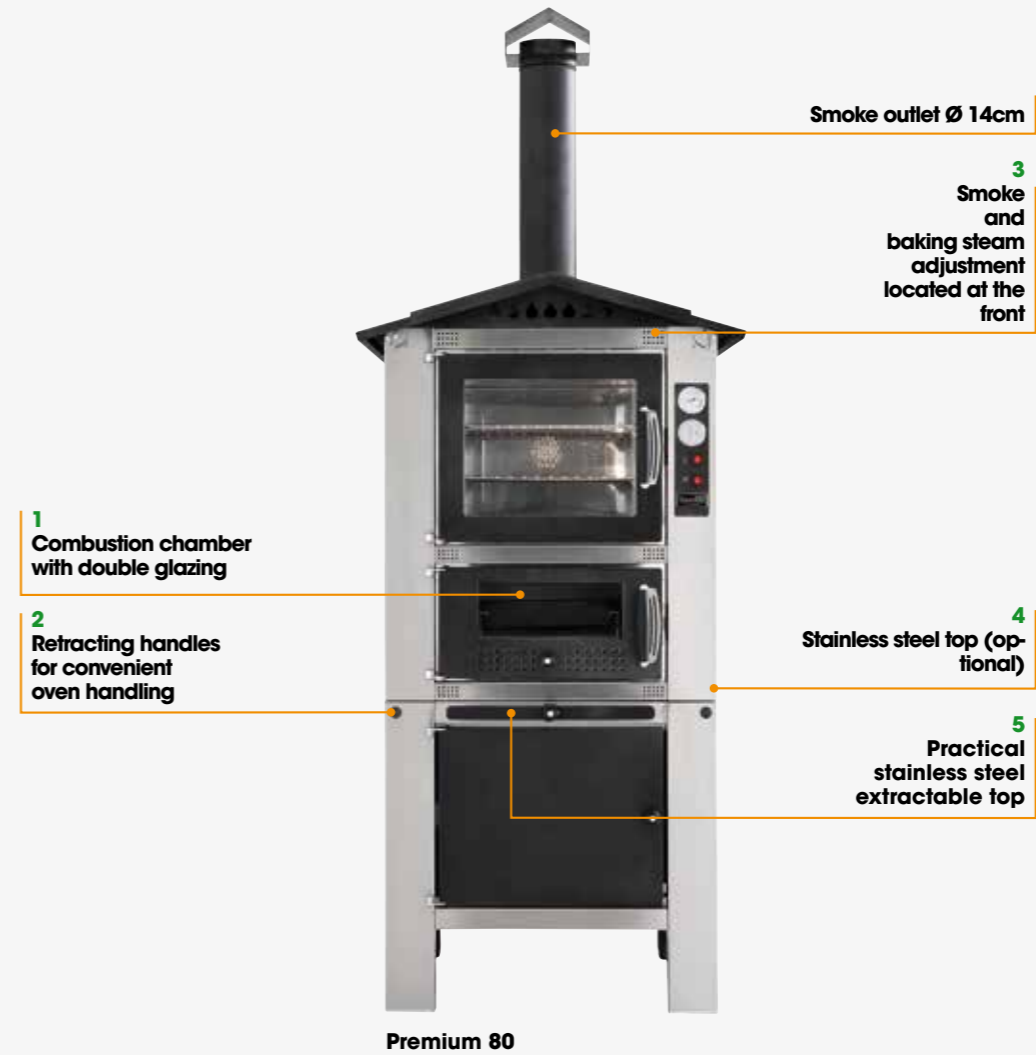

Premium 80



Multichef® Autoclean® Fireblade®

Outdoor oven in aluminised steel an with AISI 304 stainless steel cooking chamber and brushed steel front panel. Double glazed doors.

Codes
 5513001 (100) Roof 4013018
 5513002 (80) Roof 4013019
 5513003 (60) Roof 4013020
 5510016 (Oven cart 100)
 5510017 (Oven cart 80)
 5510018 (Oven cart 60)

Cooking chamber
 100 x 52 x h 39 cm (Premium 100)
 80 x 47 x h 34 cm (Premium 80)
 60 x 47 x h 34 cm (Premium 60)

Weight (Oven cart not included)
 287 kg (Premium 100)
 212 kg (Premium 80)
 176 kg (Premium 60)
 45 kg (100)
 40 kg (80)
 35 kg (60)

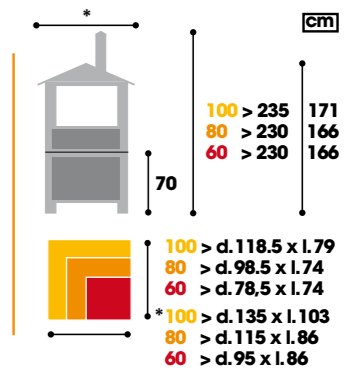

See pricelist for more detailed measurements

STANDARD EQUIPMENT: refractory material surface, 2 wire racks, 1 rectangular tray.





Premium Comfort Air®

The oven that heats the room while you are cooking.

1 Front panel made in stainless steel

2 Ready for Comfort Air hot air ducting system®



3 Smoke and baking steam adjustment located at the front

4 Combustion chamber with double glazing



Indoor Premium version with room heating feature via patented Comfort Air system® (extra) which ducts air up to 8 metres.

Codes
 5513001 (100) Roof 4013021
 5513002 (80) Roof 4013022
 5513003 (60) Roof 4013023

Cooking chamber
 100 x 52 x h 39 cm (Premium 100)
 80 x 47 x h 34 cm (Premium 80)
 60 x 47 x h 34 cm (Premium 60)

Weight
 279 kg (Premium 100)
 203 kg (Premium 80)
 169 kg (Premium 60)

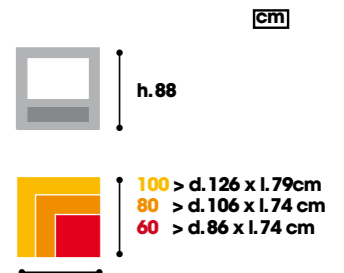

See pricelist for more detailed measurements

STANDARD EQUIPMENT: refractory material surface, 2 wire racks, 1 rectangular tray.



Arcos



Aluminised steel outdoor oven, bronze-colour steel front panel with AISI 430BA stainless steel cooking chamber and vaulted double glazed door.

Codes
 5513008 (100) Roof 4013018
 5513009 (80) Roof 4013019
 5513010 (60) Roof 4013020
 5510016 (Oven cart 100)
 5510017 (Oven cart 80)
 5510018 (Oven cart 60)

Cooking chamber
 100 x 52 x h 39 cm (Arcos 100)
 80 x 47 x h 34 cm (Arcos 80)
 60 x 47 x h 34 cm (Arcos 60)

Weight
 287 kg (Arcos 100)
 223 kg (Arcos 80)
 193 kg (Arcos 60)
 45 kg (100)
 40 kg (80)
 35 kg (60)

STANDARD EQUIPMENT: refractory material surface, 2 wire racks, 1 rectangular tray.

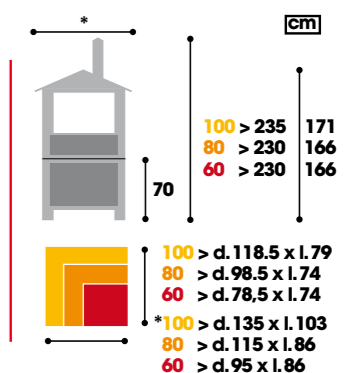

See pricelist for more detailed measurements



Arcos Comfort Air®

The oven that heats the room while you are cooking.

1 Ready for hot air Comfort Air ducting system®



2 Combustion chamber with glass



Arcos indoor version with room heating feature via Comfort Air patented system® (extra) which ducts hot air up to 8 metres.

Codes
5513008 (100) Roof 4013021
5513009 (80) Roof 4013022
5513010 (60) Roof 4013023

Cooking chamber
100 x 52 x h 39 cm (Arcos 100)
80 x 47 x h 34 cm (Arcos 80)
60 x 47 x h 34 cm (Arcos 60)

Weight
282 kg (Arcos 100)
215 kg (Arcos 80)
186 kg (Arcos 60)

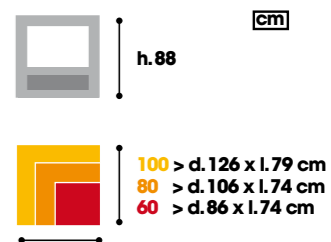

See pricelist for more detailed measurements

STANDARD EQUIPMENT: refractory material surface, 2 wire racks, 1 rectangular tray.



Easy



1 Burgundy coloured steel front panel

Smoke outlet Ø 14cm

2 Retractable handles for convenient oven handling



Outdoor oven in painted aluminised steel, AISI 430 BA steel cooking chamber. Tempered glass door

Codes
5512026
EASY OVEN W/CART

Cooking chamber
80 x 45 x h 38 cm

Weight
215 kg

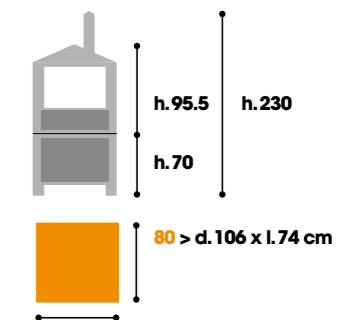

See pricelist for more detailed measurements

STANDARD EQUIPMENT: refractory material surface, 2 wire racks, 1 rectangular tray.

Ovens in refractory material.



Ancient flavours and natural gestures connected to tradition and the joy of cooking with your own hands. Sunday offers vault ovens entirely made in Alutec®, an innovative refractory material with high alumina content (70%), designed to withstand high temperatures and conserve heat, at the same time as assuring long lasting efficiency over the years.

Recommendations for installation

Installation site

Ovens in refractory material can be installed indoors or outside, as for instance porches.

The components of the base and vault may be dry assembled onto a solid masonry base. For good combustion and smoke exhaust, it is recommended to comply with the installation values provided and to use the handy smoke-fitting accessory.

The outer structure has the purpose of embellishing the oven and protecting it, containing the inner structure and isolating the refractory material vault.



Cooking suggestions

With a Sunday® refractory material oven, a range of Italian recipes can be cooked traditionally. The cooking methods are divided into two main types: direct flame cooking and "indirect" heat cooking.

In the first method, you cook with the direct heat of the fire lit inside the refractory material vault; it is the ideal system to roast meat, as well as fish and, obviously, real Italian wood oven pizza!

With the second system, the heat slowly transferred by the refractory material walls is used to bake bread or other delicate food like ham or Porchetta.

Type of oven	Minutes to reach temperature	Number of pizzas	Bread batch
VOLTA 120	60	6/7	14 Kg
VOLTA 100	60	5	10 Kg
VOLTA 80	60	3/4	8 Kg
QUADRO	60	2/3	6 Kg
MINI	60	2	-

Volta 120 Oven

Small-sized components, accurately jointed, for easy and safe assembly

Steel door with external thermometer

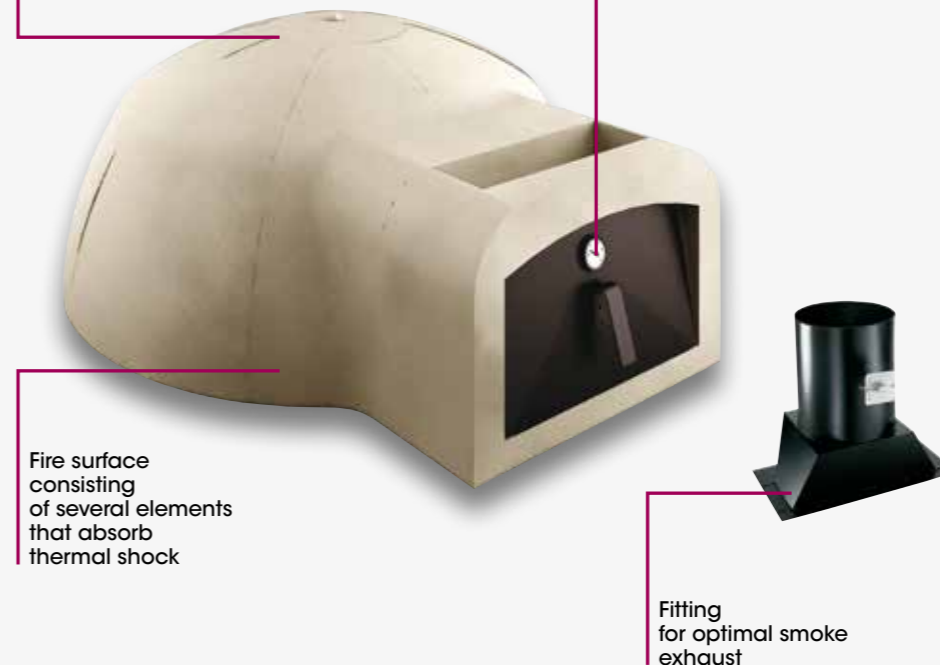

Fire surface consisting of several elements that absorb thermal shock

Fitting for optimal smoke exhaust

It uses wood

Vault oven entirely made in Alutec®, fitted with metal door and thermometer (the smoke fitting, needed for operation, must be ordered separately).
Code 55029

Weight kg 520
Packaging 120x105cm

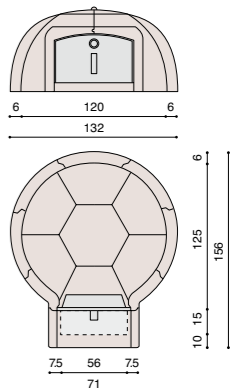
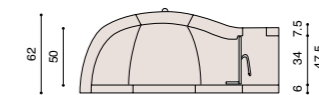

Recommended accessories
> 40140104 Glazed oven door - Volta 100/120 Oven
> 4009049 pizza accessory kit with spatula and knife

> 4012057 Barbecue/oven glove
> 4012028 BBQ and Oven cleaning set
> 40160029 Smoke fitting with valve for Vaulted Oven 100/120
> 4010073 Insulation fibre ceramic mat (8.92 sqm)

minimum room volume
m³ 192

optimal consumption
kg | h16

external air intake
cm² 500

flue
35x35

useful diameter cm
Ø 35

height m
3.5 | 5.5

flue
30x30

useful diameter cm
Ø 30

height m
over 5.5



Volta 100 Oven

Small-sized components, accurately jointed, for easy and safe assembly

Steel door with external thermometer



Fire surface consisting of several elements that absorb thermal shock

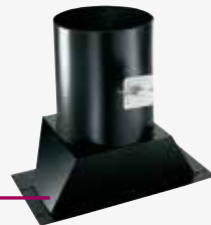

Fitting for optimal smoke exhaust

It uses wood

Vault oven entirely made in Alutec®, fitted with metal door and thermometer (the smoke fitting, needed for its operation, must be ordered separately).

Code
55028

Weight
kg 416
Packaging
110x100cm

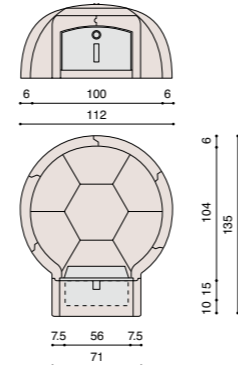
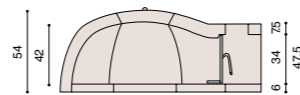

Recommended accessories
> 40140104 Glazed oven door - Volta 100/120 Oven
> 4009049 pizza accessory kit with spatula and knife

> 4012057 Barbecue/oven glove
> 4012028 BBQ and Oven cleaning set
> 40160029 Smoke fitting with valve for Vaulted Oven 100/120
> 4010073 Insulation fibre ceramic mat (8.92 sqm)

Volta 80 Oven

Small-sized components, accurately jointed, for easy and safe assembly

Steel door with external thermometer



Fire surface consisting of several elements that absorb thermal shock



Fitting for optimal smoke exhaust

It use wood

Vault oven entirely made in Alutec®, fitted with metal door and thermometer (the smoke fitting, needed for its operation, must be ordered separately).

Code
55027

Weight
kg 369
Packaging
110x82cm

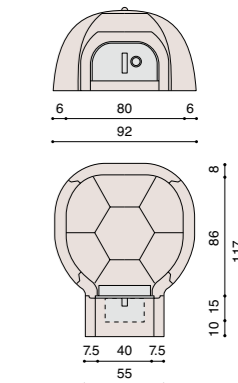
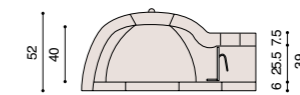

Recommended accessories
> 40140103 Glazed oven door - Volta 80 Oven
> 4009049 pizza accessory kit with spatula and knife

> 4012057 Barbecue/oven glove
> 4012028 BBQ and Oven cleaning set
> 40160030 Smoke fitting with valve for Volta Oven 80
> 4010073 Insulation fibre ceramic mat (8.92 sqm)

minimum room volume
m³ 132

optimal consumption
kg | h 11

external air intake
cm² 350

flue
30x30

useful diameter cm
Ø 30

height m
3.5 | 5.5

flue
25x25

useful diameter cm
Ø 25

height m
over 5.5



minimum room volume
m³ 84

optimal consumption
kg | h 7

external air intake
cm² 200

flue
25x25

useful diameter cm
Ø 25

height m
3.5 | 5.5

flue
20x20

useful diameter cm
Ø 20

height m
over 5.5



Quadro Oven

Small-sized components, accurately jointed, for easy and safe assembly

Steel door with external thermometer



Fire surface consisting of several elements that absorb thermal shock



Fitting for optimal smoke exhaust

It uses wood

minimum room volume
m³ 64

optimal consumption
kg | h 5

external air intake
cm² 150

flue
25x25

useful diameter cm
Ø 25

height m
3.5 | 5.5

flue
20x20

useful diameter cm
Ø 20

height m
4.5 | 6

flue
18x18

useful diameter cm
Ø 17

height m
over 6

Rectangular oven entirely made in Alutec®, fitted with metal door and thermometer (the smoke fitting, needed for its operation, must be ordered separately).

Code
55018

Weight
kg 300
Packaging
92x84cm

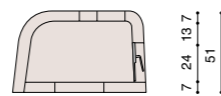

7 24 13.7 51

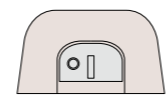

90 7 76 7

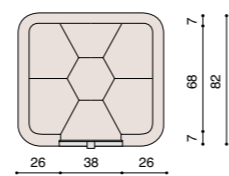

7 68 82 7 26 38 26

Recommended accessories

- > 40140102 Glazed oven door - Quadro Oven
- > 4009049 pizza accessory kit with spatula and knife

- > 4012057 Barbecue/oven glove
- > 4012028 BBQ and Oven cleaning set
- > 40160031 Smoke fitting with valve for Quadro Oven
- > 4010073 Insulation fibre ceramic mat (8.92 sqm)

Mini Oven

Small-sized components, accurately jointed, for easy and safe assembly

Steel door with external thermometer



Fire surface consisting of several elements that absorb thermal shock



Fitting for optimal smoke exhaust

It uses wood

minimum room volume
m³ 42

optimal consumption
kg | h 3.5

external air intake
cm² 100

flue
20x20

useful diameter cm
Ø 20

height m
3.5 | 4.5

flue

useful diameter cm
Ø 17

height m
over 4.5



Oven made in refractory material with high alumina content, fitted with metal door and thermometer (the smoke fitting, needed for operation, must be ordered separately).

Code 55016

Weight
kg 210
Packaging
72x72cm

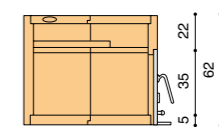

5 3.5 22 62

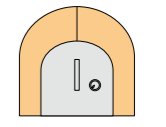

15 36 15 66

6 54 6

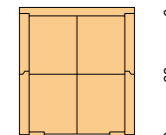

6 60 72 6 66

Recommended accessories

- > 40140101 Glazed oven door - Mini Oven
- > 4009049 pizza accessory kit with spatula and knife

- > 4012057 Barbecue/oven glove
- > 4012028 BBQ and Oven cleaning set
- > 40160084 Smoke fitting with valve for Mini Oven
- > 4010073 Insulation fibre ceramic mat (8.92 sqm)

BBQ accessories.



Cooking systems
Cooking racks

Biologic stainless steel cooking rack
400058 60x45cm



Set of 2 biologic cooking racks
4012060 40x45cm



Biologic stainless steel cooking rack
4012032 67x40cm
4012031 60x40cm
4017015 84x60cm



Chrome plated cooking rack
4012040 67x40cm
4012039 60x40cm



Chrome food warming rack
40140152 60x20cm



Cooking systems
Hot plates

Steatite steak griddle with handles
40140178 67x40cm
40140177 60x40cm

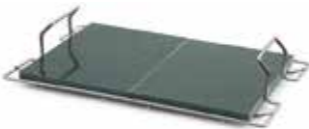

Serpentine plate
40180051 40x30cm



Steatite plate compatible with Master 4 - Profy 4
4008028 25x48.5cm (Master 4)
4011049 20.5x48.5cm (Profy 4)



Cooking systems
Rotisserie and Spit

Complete Rotisserie Kit
4008010 70cm
4008008 56cm



Electric Spit
4008056 100cm
4008055 80cm



Battery operated Spit
4008054 80cm



Cooking series brazier
4008075 - 80cm
4017016 - 60cm



Easy Fire® ember holder
for fast lighting
40140204 60x40cm

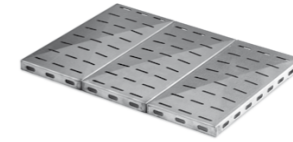

Dripping pan
cm 50x29
40140156



Cooking
Tools

Set of 5 stainless steel accessories
4012053



Set of 3 stainless steel accessories
4012054



Stainless Steel Multipurpose
Spatula
4012055



Cooking systems
Braziers

Wood Brazier with drawer
40140041 46x32cm



Vertical charcoal brazier
with feet
4008076 55cm



Vertical wood brazier
with feet
40140154 55cm

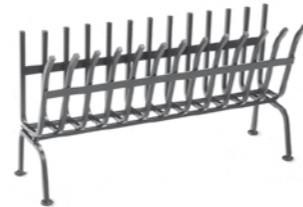

Stainless Steel Fork
4012070



Apron
4010019



Barbecue/Oven Glove
4012057



Assembly

Concrete BBQ hood extension
4027158 20x20xh25 cm
4027160 30x30xh15 cm



Betonfast Adhesive®
for BBQ assembly
4010070



Mortar for BBQ assembly
40180027 10 Kg
40180088 3 Kg



BBQ paint
White 40180040 10 Kg



BBQ paint
White 40180075 5 Kg



BBQ paint
4012068 - RAL 7011 Grey Paint
4012069 - RAL 9001 White Paint



Side top for Melody kitchens
4008084



Door for Melody kitchens
4009025



42.5x29.4 cm wood shelf
4012029



60cm black steel shelf
4012047



Protection

Masonry BBQ counter-hood
4008077 Ø 20 - 67cm
40140253 Ø 20 - 60cm

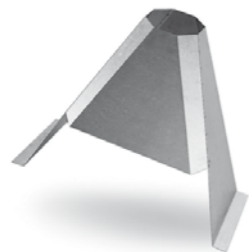

Masonry BBQ brazier protection kit
4011053 - cm 60



Ember guard
4014003 - 60cm
4014004 - 67cm



Maintenance

Protective Cover for BBQ
with 2 side benches
4009048 250x92xh220 cm - XL
4009047 220x92xh220 cm - L



BBQ Protective Cover
40180029 164x92xh240cm - M
40180031 120x80xh224cm - S



Grill cover
4015002 - L
4015003 - XL



Gas cylinder cover
4012052



Cast Iron Hot Plate
400036 32.5x48.5 cm (Profy 3 -
Master 3)
400038 24.5x48.5 cm (Master 2/4)
4011047 20.5x48.5 cm (Profy 4)



Cast Iron Hot Plate
400037 32.5x48.5 cm (Profy 3 -
Master 3/4)
400039 24.5x48.5 cm (Master 2)
4011048 20.5x48.5 cm (Profy 4)



Cast iron hot plate for Montana 3
(4015017) - Montana 4 (4015019)
Cast iron cooking rack for Mon-
tana 3 (4015018) - Montana 4
(4015020)
20,5x43 cm (3) - 20,5x43 cm (4)



Texas 3 stainless st. cooking rack - 4013026
Texas 4 stainless st. cooking rack - 4013027

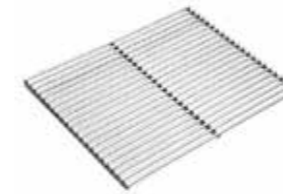

Support rack for lava rock
400046



Lava rock package
4015021 3Kg

Texas 3/4 cooking rack and lava rock kit
4013025



Cleaning Tools

Grid cleaning brush
400009



Oven accessories.

Carts

Premium oven cart
5510016 (100)
5510017 (80)
5510018 (60)



Arcos oven cart
5510019 (100)
5510020 (80)
5510021 (60)



chrome Porchetta roasting rack
4010052 / 60 oven
4010060 / 80 oven
4010061 / 100 oven



stainless steel cart
with aluminium tray
4010034 h.6 / 60 oven
4010035 h.6 / 80 oven
4010036 h.6 / 100 oven



refractory material pizza plate
4010029 / 60 oven
4010030 / 80 oven
4010031 / 100 oven



Comfort Air Kit

Comfort Air Kit®
4010017
(refer to the price list for individual accessories)



Maintenance and assembly

protective bag
4010042 / 60 oven
4010043 / 80 oven
4010044 / 100 oven



steam smoke manifold
4010040
ovens 45 / 60 / 80 / 100



stainless steel side shelf
4010037 / 60 oven
4010038 / 80 oven
4010039 / 100 oven



Tools

pizza shovel
4010018



rectangular chrome cooking rack
4010045 43x43 / 45 oven
4010046 43x59 / 60 oven
4010047 43x79 / 80 oven
4010048 53x99 / 100 oven

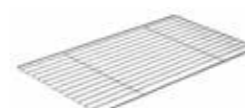

Smoke fitting with valve
for vaulted oven
40160029 100/120
40160030 80



Smoke fitting with valve
40160031 quadro oven
40160084 mini oven



Glass oven door
40140104 volta 100/120 oven
40140103 volta 80 oven
40140102 quadro oven
40140101 mini oven



Cooking systems Trays

aluminium tray
4010022 43x40 h.4
4010049 43x40 h.6
4010023 40x60 h.4
4010050 40x60 h.6
4010024 40x80 h.4
4010051 40x80 h.6
4010025 47x100 h.6



ø 38 h round aluminium tray.3
4010026



ø 34 pizza aluminium tray
4010027



Fibre ceramic
insulation mat (8.92 sqm)
4010073

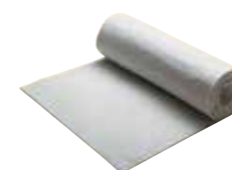

Flexible steel pipe
40160048



White air inlet nozzle
40160001



MCZ Group Spa
via La Croce 8
33074 Vigonovo di Fontanafredda (PN)
Italia

T +39 0434 599599
F +39 0434 599598
W www.sundaygrill.com